

HIGHLAND

*MODULAT KITCHEN &
INTERIORS*



IMPORTANT KITCHEN DETAILS

Kitchen Counter Height & Cabinet Size Guide

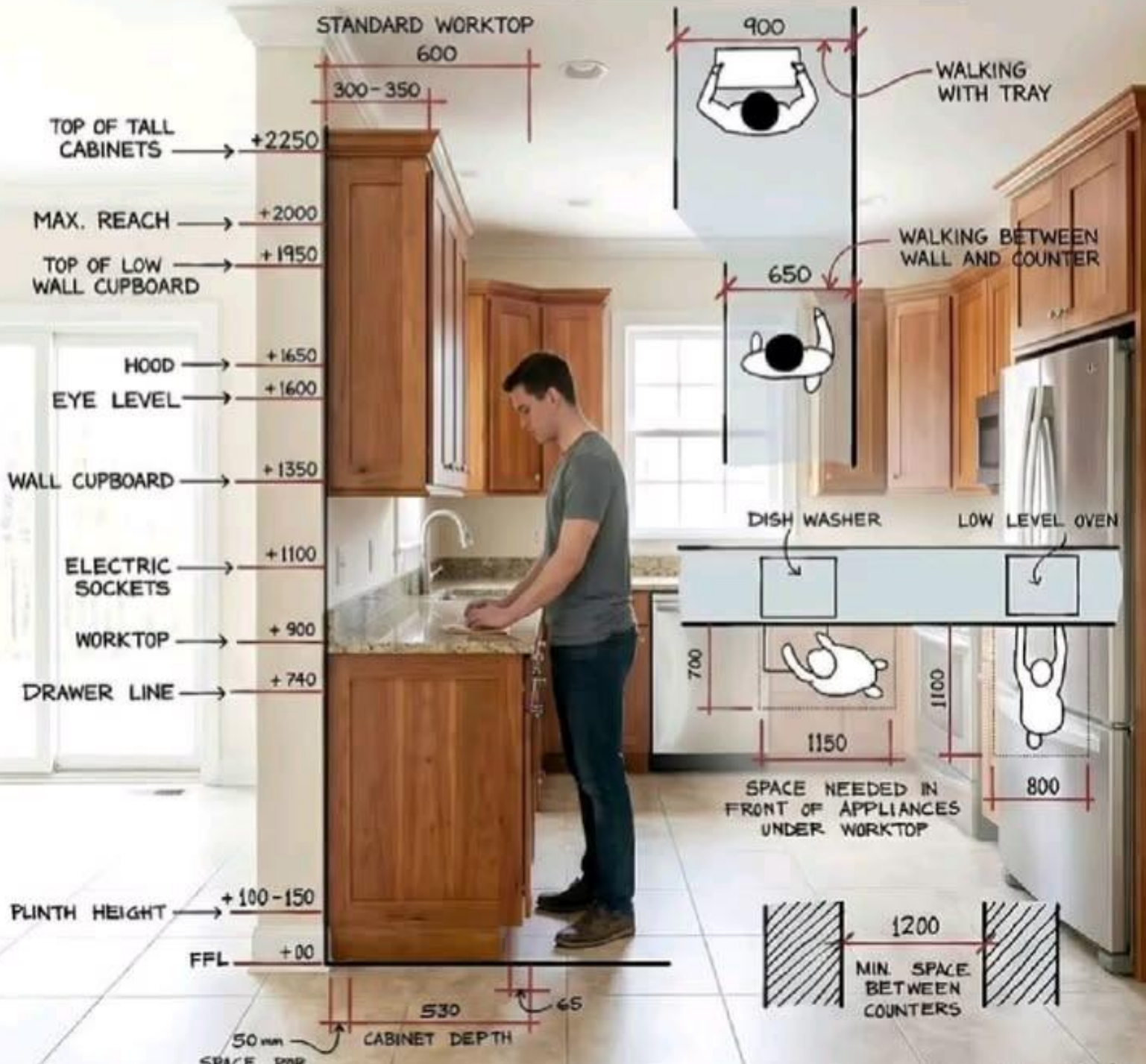

Modular Kitchen for all styles



Straight

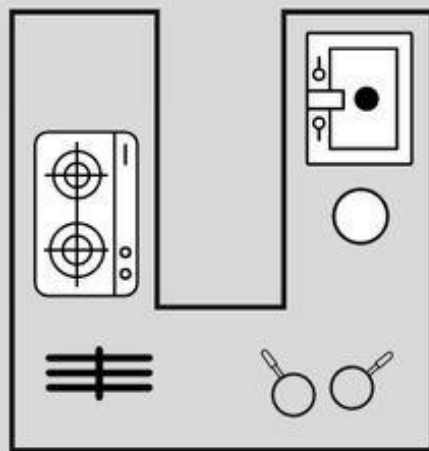

U-shaped



Parallel

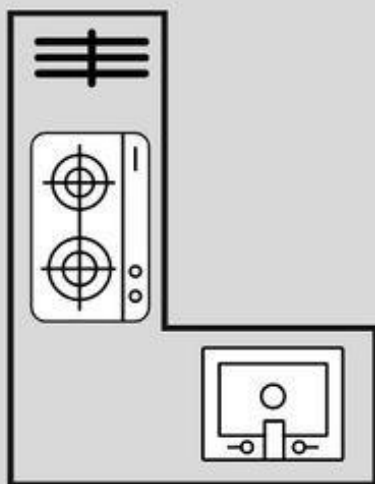

L-shaped

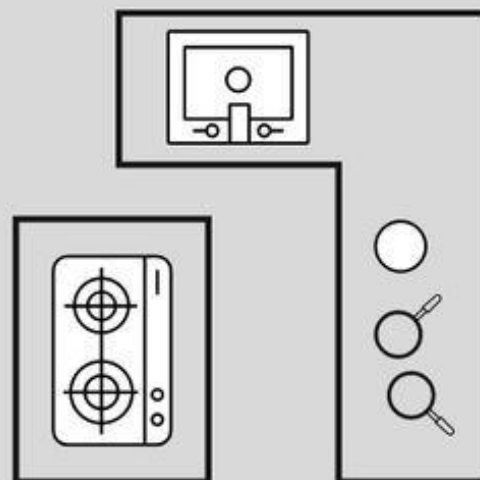

Island

Kitchen Work Triangle

Galley Kitchen

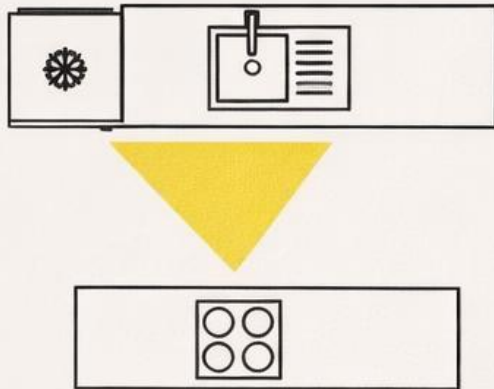

L-Shaped Kitchen

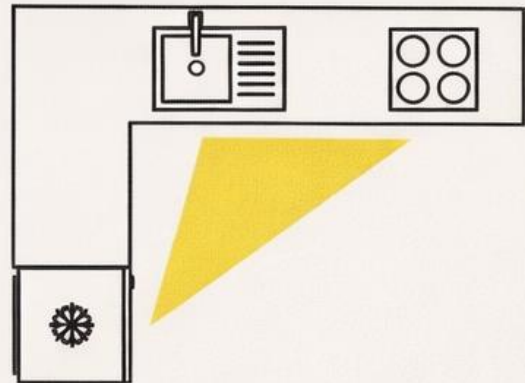

Single Wall Kitchen

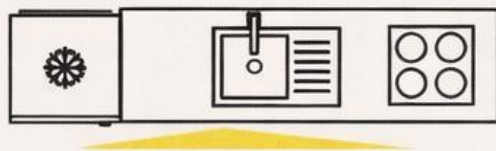

U-Shaped Kitchen

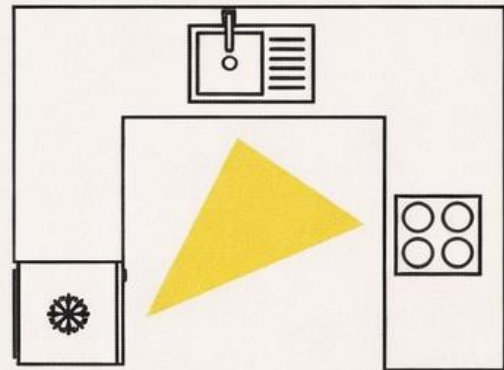

L Shape with Island

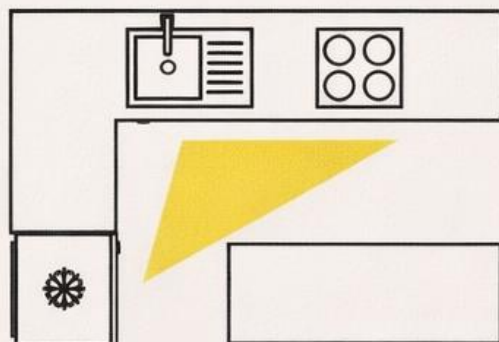

G-Shaped Kitchen

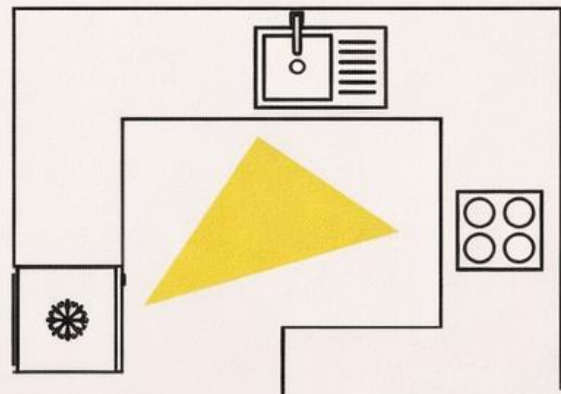

Best Kitchen Shutter Finishes



Laminate – Durable & budget friendly

Acrylic – Glossy & modern



Membrane – Smooth & water resistant



PU Paint – Premium seamless finish



Glass – Stylish & elegant



Stone – Heat & stain resistant

Profile Glass – Functional & sleek

Types of Hinges

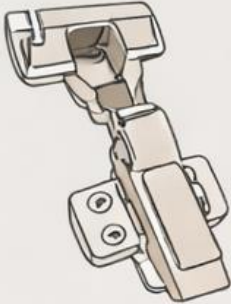

0° Crank Hinge

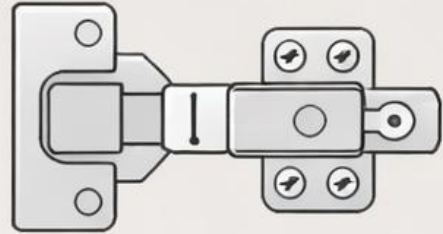

8° Crank Hinge

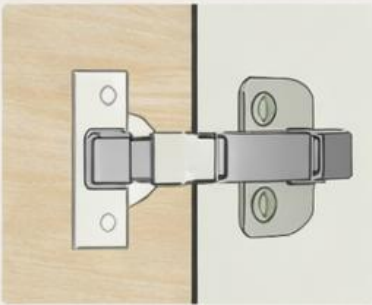

15° Crank Hinge

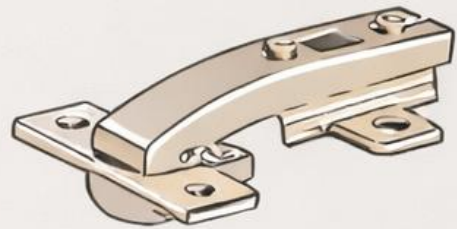

Blind Corner Hinge

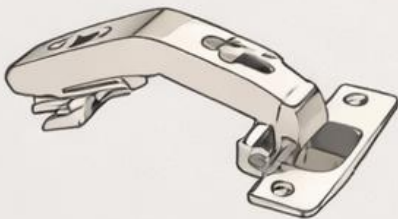

Pie Hinge

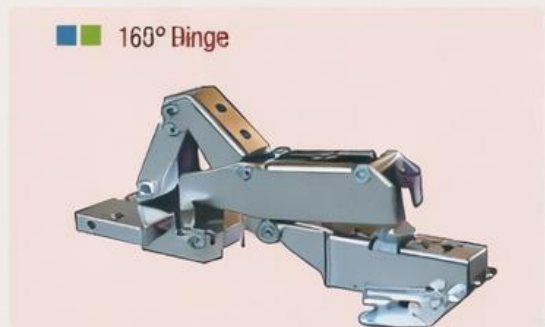

160° Hinge

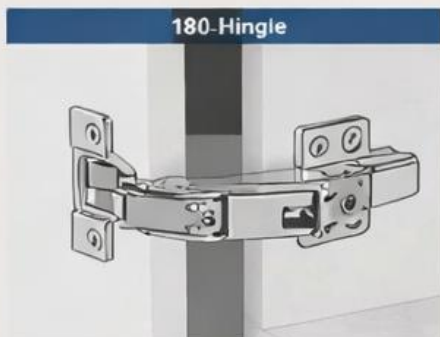

180-Hinge

DIFFERENT TYPE OF HAFELE DRAWER SYSTEM



MATRIXBOX PREMIUM



MATRIXBOX SLIM

DIFFERENT TYPE OF BLUM DRAWER SYSTEM



TANDEMBOX ANTARO



LEGRABOX

DIFFERENT TYPE OF HETTICH DRAWER SYSTEM



AVANTECH



ARCITECH



INNOTECH

1 - Plinth pod



2 - Deep drawer



3 - Deep drawer



4 - internal drawer





SS TROLLEY INTERNAL DETAIL

Basic Cutlery Material

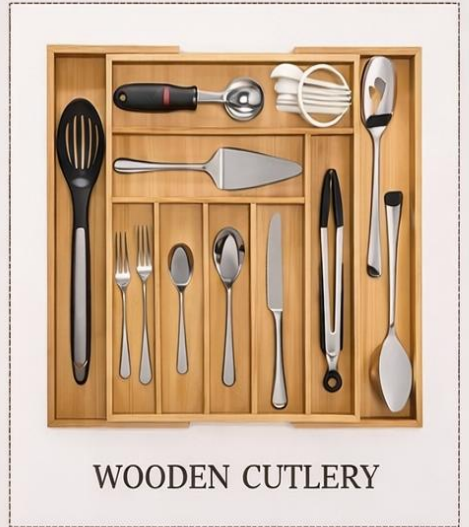
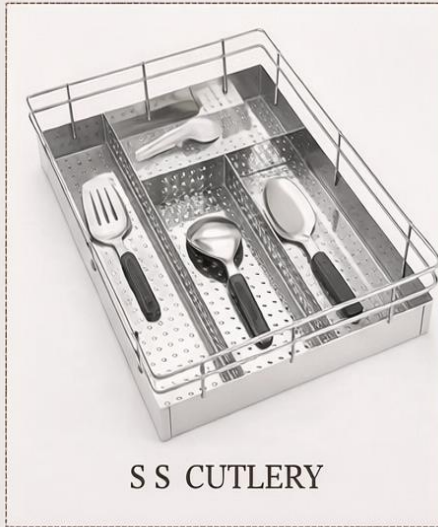
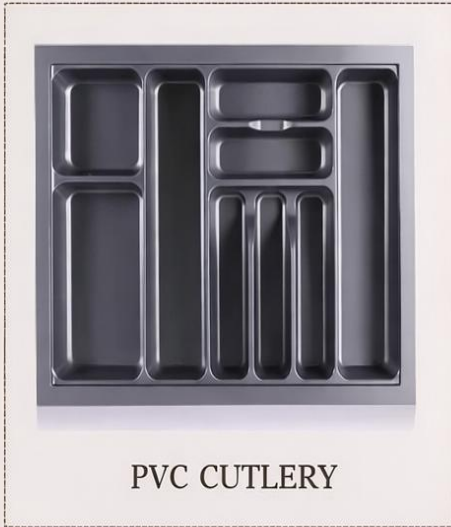

Basic Kitchen Accessories & Hardware



DISHRACK



CUTLERY



WICKER BASKET

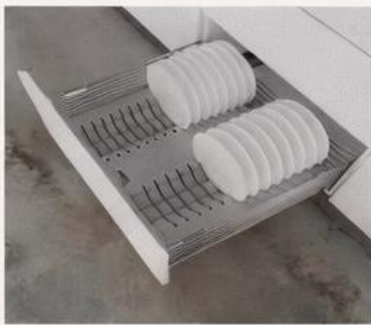

PLATE BASKET



**DETERGENT
HOLDER**



DUSTBIN



**MICROWAVE
STAND**



B.P.O



SPICE RACK



TOWEL HOLDER



PANTRY

Basic Kitchen Corner Solution



Magic Corner



Lemans Corner



Corner Drawer



Carousel



Dee Tray

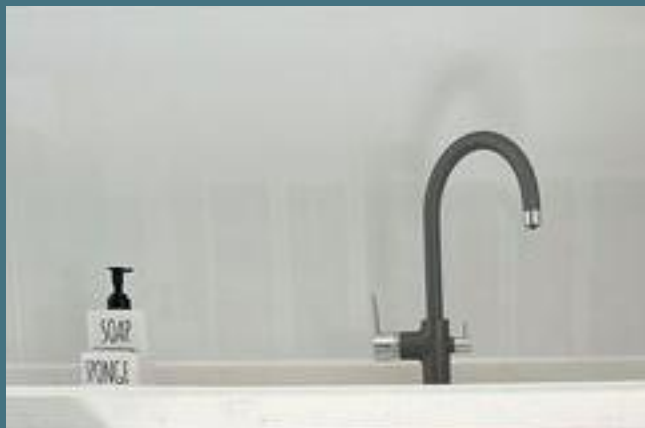

**MODERN
SOLUTIONS
FOR
KITCHEN
SINK**

Variety Of Dustbin For Modular kitchen



Worktop Waste Bin

Waste Basket with Handle



Auto Lid Dustbin

Pull Out Dustbin



MODULAR KITCHEN LIFT-UP MECHANISM

GAS LIFT-UP



DUO LIFT-UP



SINGLE SHUTTER
AVENTOS



DOUBLE SHUTTER
AVENTOS



DIFFERENT TYPE OF ROLLING SHUTTER



PVC ROLLING SHUTTER



ALUMINUM ROLLING SHUTTER



GLASS ROLLING SHUTTER

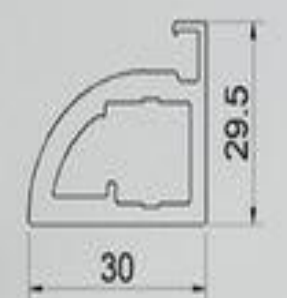
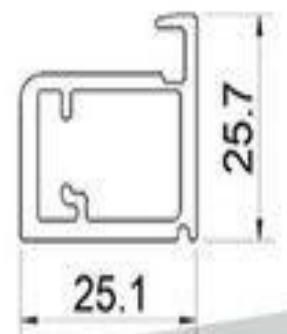
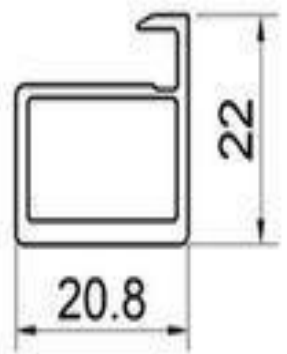
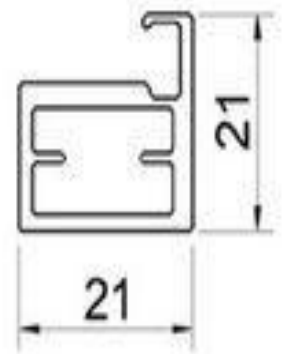
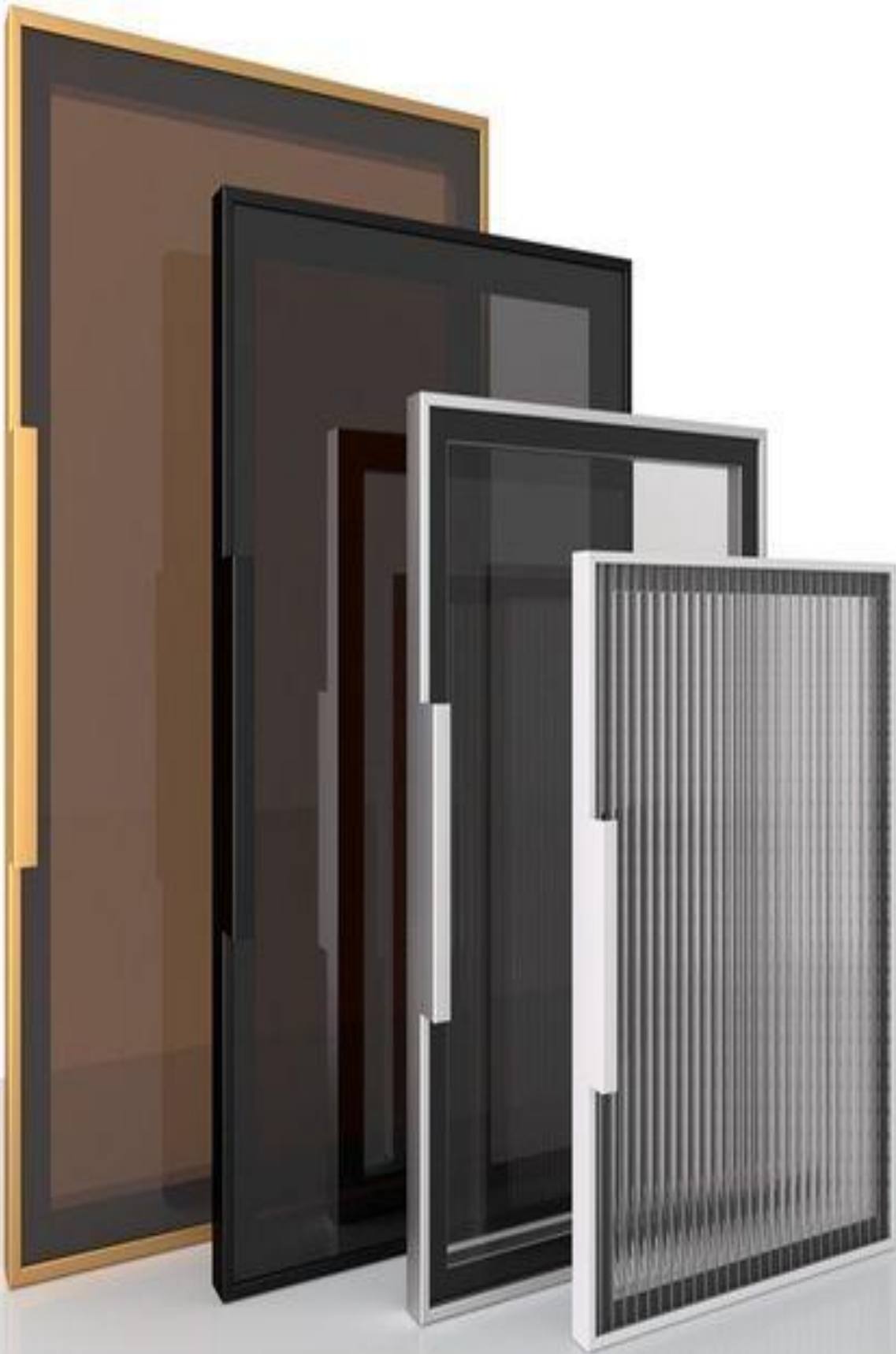

Grey Fluted

Brown fluted





ARCHITECT

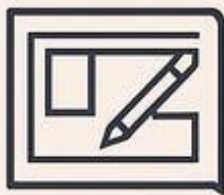

- Conceptualizes and designs buildings from the ground up
- Handles structure, form, façade, and spatial organization
- Works with building codes, zoning, and construction systems
- Focuses on the overall vision, safety, and functionality of the building

INTERIOR DESIGNER



- Designs interior spaces within an existing structure
- Works on layouts, finishes, lighting, furniture, and materials
- Ensures comfort, usability, and aesthetics indoors
- Aligns interiors with client lifestyle and functional needs

INTERIOR DESIGN PROCESS

SPACE PLANNING

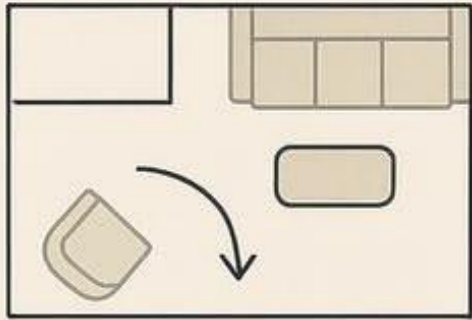

FURNITURE LAYOUT

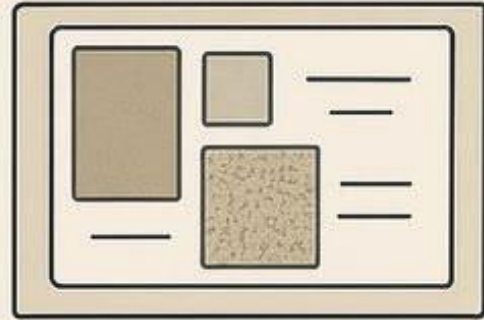

MOODBOARD CREATION

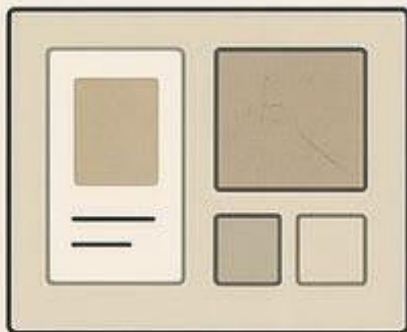

MATERIAL SELECTION

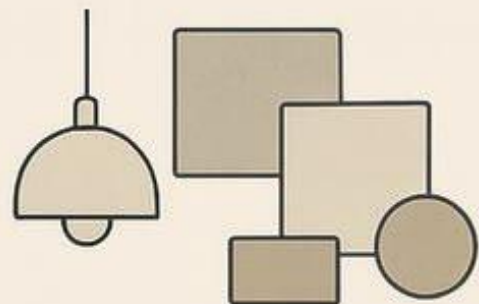

LIGHTING DESIGN



COLOR PALETTE



STYLING & FINAL TOUCHES



















Thank You