



# 2025-26

## PRODUCT CATALOGUE

**XGT**

Nut-busting  
torque  
**4,000**  
N·m



**TW009G**  
Cordless Impact Wrench

## MAKITA CORDLESS PART NUMBER BREAKDOWN

	Charger	Description	Battery	Description	Battery Qty	Others
Z						Tool Only (Batteries, Charger not included)
DSE	DC10WA	10.8V Standard Charger	BL1013	10.8V, 1.3Ah	2	
DWE	DC18WA	18V Standard Charger	BL1815G	18V, 1.5Ah	2	
DWX	DC10WA	10.8V Standard Charger	BL1013	10.8V, 1.3Ah	1	
GA101	DC40RA	40V Rapid Charger	BL4020	40V, Max 2.0Ah	1	
GD201	DC40RA	40V Rapid Charger	BL4025	40V, Max 2.5Ah	2	
GM101	DC40RA	40V Rapid Charger	BL4040	40V, Max 4.0Ah	1	
GM201	DC40RA	40V Rapid Charger	BL4041	40V, Max 4.0Ah	2	
GM202	DC40RA	40V Rapid Charger	BL4040	40V, Max 4.0Ah	2	
GT201	DC40RA	40V Rapid Charger	BL4050F	40V, Max 5.0Ah	2	
PT2	DC18RD	18V Rapid Charger Dual Port	BL1850B	18V, 5.0Ah	2	
RFE	DC18RC	18V Rapid Charger	BL1830B	18V, 3.0Ah	2	
RFJ	DC18RC	18V Rapid Charger	BL1830B	18V, 3.0Ah	2	Makpac
RFX1 / RFX4	DC18RC	18V Rapid Charger	BL1830B	18V, 3.0Ah	2	74 nos Bit Set
RM	DC18RC	18V Rapid Charger	BL1840B	18V, 4.0Ah	1	
RME	DC18RC	18V Rapid Charger	BL1840B	18V, 4.0Ah	2	
RT	DC18RC	18V Rapid Charger	BL1850B	18V, 5.0Ah	1	
RTE	DC18RC	18V Rapid Charger	BL1850B	18V, 5.0Ah	2	
RTJ / RTJX7	DC18RC	18V Rapid Charger	BL18508	18V, 5.0Ah	2	Makpac
SAE	DC10SB	12V Standard Charger	BL1021B	12V, Max 2.0Ah	2	
SF	DC18SD	18V Standard Charger	BL1830B	18V, 3.0Ah	1	
SFE	DC18SD	18V Standard Charger	BL1830B	18V, 3.0Ah	2	
SFE3	DC18SD	18V Standard Charger	BL1830B	18V, 3.0Ah	3	
SFX1	DC18SD	18V Standard Charger	BL1830B	18V, 3.0Ah	2	Tool Bag
SYE	DC18SD	18V Standard Charger	BL1815N	18V, 1.5Ah	2	
WAE	DC10WD	12V Standard Charger	BL1021B	12V, Max 2.0Ah	2	
WAX1	DC10WD	12V Standard Charger	BL1021B	12V, Max 2.0Ah	2	74nos bit set
WYE	DC10WD	12V Standard Charger	BL1016	12V, Max 1.5Ah	2	
WYJ	DC10WD	12V Standard Charger	BL1016	12V, Max 1.5Ah	2	Makpac
ZJ						Tool Only, Connector Case

# MAKPAC Power source kit



**40V<sub>max</sub>**  
Lithium-ion

**18V**  
Lithium-ion

**12V<sub>max</sub>**  
Lithium-ion

**18V**  
Lithium-ion

**12V<sub>max</sub>**  
Lithium-ion

Model No.	MAKPAC type	Set contents				
		Battery	Ah	Qty	Charger	Converter
MKP1G001	TYPE1	BL4025	2.5Ah	2	DC40RA	
MKP1G002	TYPE1	BL4040	4.0Ah	2	DC40RA	
MKP1SY182	TYPE1	BL1815N	1.5Ah	2	DC18SD	
MKP1RA182	TYPE1	BL1820B	2.0Ah	2	DC18RC	
MKP1RF181	TYPE1	BL1830B	3.0Ah	1	DC18RC	
MKP1RF182	TYPE1	BL1830B	3.0Ah	2	DC18RC	
MKP1RF183	TYPE1	BL1830B	3.0Ah	3	DC18RC	
MKP1RF184	TYPE1	BL1830B	3.0Ah	4	DC18RC	
MKP1RM182	TYPE1	BL1840B	4.0Ah	2	DC18RC	
MKP1RM183	TYPE1	BL1840B	4.0Ah	3	DC18RC	
MKP1RM184	TYPE1	BL1840B	4.0Ah	4	DC18RC	
MKP1RT181	TYPE1	BL1850B	5.0Ah	1	DC18RC	
MKP1RT182	TYPE1	BL1850B	5.0Ah	2	DC18RC	
MKP1T188	TYPE1	BL1850B	5.0Ah	8	-	
MKP1RG181	TYPE1	BL1860B	6.0Ah	1	DC18RC	
MKP1RG182	TYPE1	BL1860B	6.0Ah	2	DC18RC	
MKP1RG183	TYPE1	BL1860B	6.0Ah	3	DC18RC	
MKP1RG184	TYPE1	BL1860B	6.0Ah	4	DC18RC	
MKP2RFC2	TYPE2	BL1830B	3.0Ah	2	DC18RC	BCV03
MKP2RFC3	TYPE2	BL1830B	3.0Ah	3	DC18RC	BCV03
MKP2RFC4	TYPE2	BL1830B	3.0Ah	4	DC18RC	BCV03
MKP2PF184	TYPE2	BL1830B	3.0Ah	4	DC18RD	
MKP2RMC2	TYPE2	BL1840B	4.0Ah	2	DC18RC	BCV03
MKP2PM184	TYPE2	BL1840B	4.0Ah	2	DC18RD	
MKP2PT184	TYPE2	BL1850B	5.0Ah	4	DC18RD	
MKP3PM182	TYPE3	BL1840B	4.0Ah	2	DC18RD	
MKP3PM184	TYPE3	BL1840B	4.0Ah	4	DC18RD	
MKP3PT182	TYPE3	BL1850B	5.0Ah	2	DC18RD	
MKP3PT184	TYPE3	BL1850B	5.0Ah	4	DC18RD	
MKP3PG182	TYPE3	BL1860B	6.0Ah	2	DC18RD	
MKP3PG184	TYPE3	BL1860B	6.0Ah	4	DC18RD	
MKP2NX1	TYPE3	BL1021B / BL1850B	2.0Ah / 5.0Ah	1	DC18RE	
MKP2NX2	TYPE3	BL1021B / BL1850B	2.0Ah / 5.0Ah	2	DC18RE	
MKP2NX3	TYPE3	BL1041B / BL1850B	4.0Ah / 5.0Ah	1	DC18RE	
MKP2NX4	TYPE3	BL1041B / BL1850B	4.0Ah / 5.0Ah	2	DC18RE	
MKP1WY122	TYPE1	BL1016	1.5Ah	2	DC10WD	
MKP1SY122	TYPE1	BL1016	1.5Ah	2	DC10SB	
MKP1WA122	TYPE1	BL1021B	2.0Ah	2	DC10WD	
MKP1SA122	TYPE1	BL1021B	2.0Ah	2	DC10SB	
MKP1WM122	TYPE1	BL1041B	4.0Ah	2	DC10WD	
MKP1SM122	TYPE1	BL1041B	4.0Ah	2	DC10SB	

## MAKPAC trolley

able to stack on for easy loading

Part No.  
TR00000002  
TR00000001(EU)



## MAKPAC adapter set

Makita AC Vacuum Cleaner to connect with MAKPAC

Part No.  
198730-6 / 198599-8(EU)

Model No.  
VC001G,L VC002GL, VC003GL, VC004GL,  
VC005GL, VC3211H/M, VC2211M, VC2201M,  
VC1310L, VC2510L, VC3210L



## MAKPAC organizer

ideal for accessory cases

Part No.  
MAKPAC organizer set  
191X80-2

MAKPAC organizer set (No box)  
191X84-4



## Cool Box

20mm thickness formed polystyrene, sealing strips are placed around the mating surface of lid and box.

**18L** Part No.  
198253-4 (Type 4)  
500mL  $\times 20$  2L  $\times 4$



**11L** Part No.  
198254-2 (Type 3)  
500mL  $\times 10$  2L  $\times 2$



# 40V Li-ion max

# XGT

## XGT Battery Series



Max Output  
**0.9 kW**



Max Output  
**1.1 kW**



Max Output  
**1.5 kW**



**2.0Ah** BL4020



**2.5Ah** BL4025



**4.0Ah** BL4040

XGT is a new system with its own tools, batteries, and chargers. A combination of innovative tool design and higher output batteries provide a genuine solution for high demand industrial users.

### Optimum power supply system and Optimum charging system

The XGT range of tools and batteries come with a built-in program, providing digital communication between the battery and tool. Allowing not only for the battery to talk with tool but also the tool to talk to the battery. Battery technology and motor engineering that work together for optimum performance.

Tool ↔ Battery ↔ Battery Charger  
Digital communication

### Optimum charging system

Auto maintenance system with two cooling fans for providing more optimum fast charging



# 40Vmax mechanism movie

This movie was filmed in Japan.  
Models and specs may vary by country.



Max Output

**2.1 kW**



Max Output

**2.8 kW**



**4.0 Ah** BL4040F

**5.0 Ah** BL4050F



**8.0 Ah** BL4080F

**POWER**

## Built Tough

High durability specifications specially designed for 40Vmax Li-Ion batteries

4-LED fuel gauge indicator

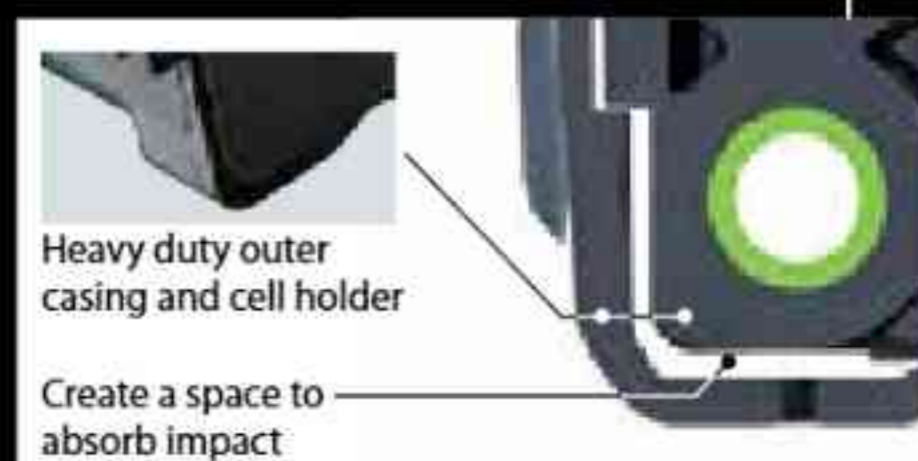

Heavy duty outer casing and cell holder

Create a space to absorb impact

**Shock absorption structure**

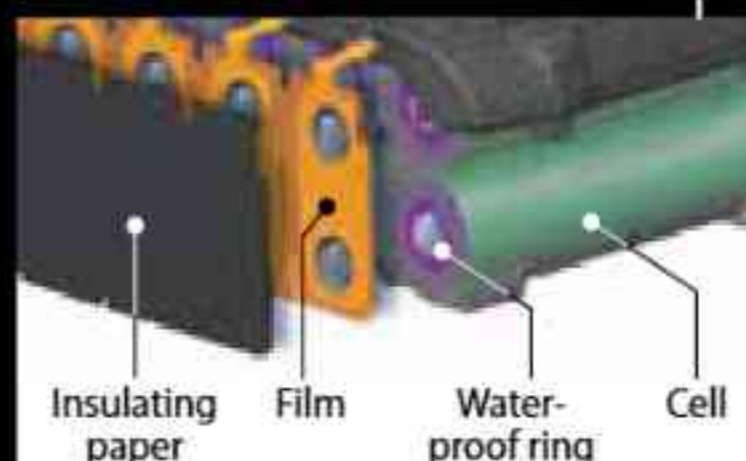

Insulating paper Film Water-proof ring Cell

**Waterproof Triple-layer Structure** prevents cell failure due to water and dust.



**Terminal short-circuit prevention structure**  
The protection wall is provided between terminals against water and dust.



**High Rigidity Battery Rails**  
Durable slide in battery rail that holds the battery and the tools firmly and securely to withstand high power products

# 40V<sup>Li-ion</sup> max

# XGT

## High Output Battery Series



**BL4040F**  
[Tab-less]



**BL4050F**



**BL4080F**



**Unlocks the full power potential for certain**



**Demonstrates tenacity even under heavy**

### BL4040F Tab-less Battery

**Traditional**



Higher electrical resistance

Energy converts to heat

Leading to energy loss

**Tab-less**



Lower electrical resistance

Energy does not easily convert to heat

Minimal energy loss

**BL4050F (Traditional)**



**20 cells**  
(2P10S)

**BL4040F (Tab-less)**



**10 cells**  
(1P10S)



## Unlocks the full power potential for certain models.

By using the high output battery, the overload indicator setting changes thanks to the smart system, allowing for continuous heavy load work, thereby improving efficiency and unlocking the full power of certain models.

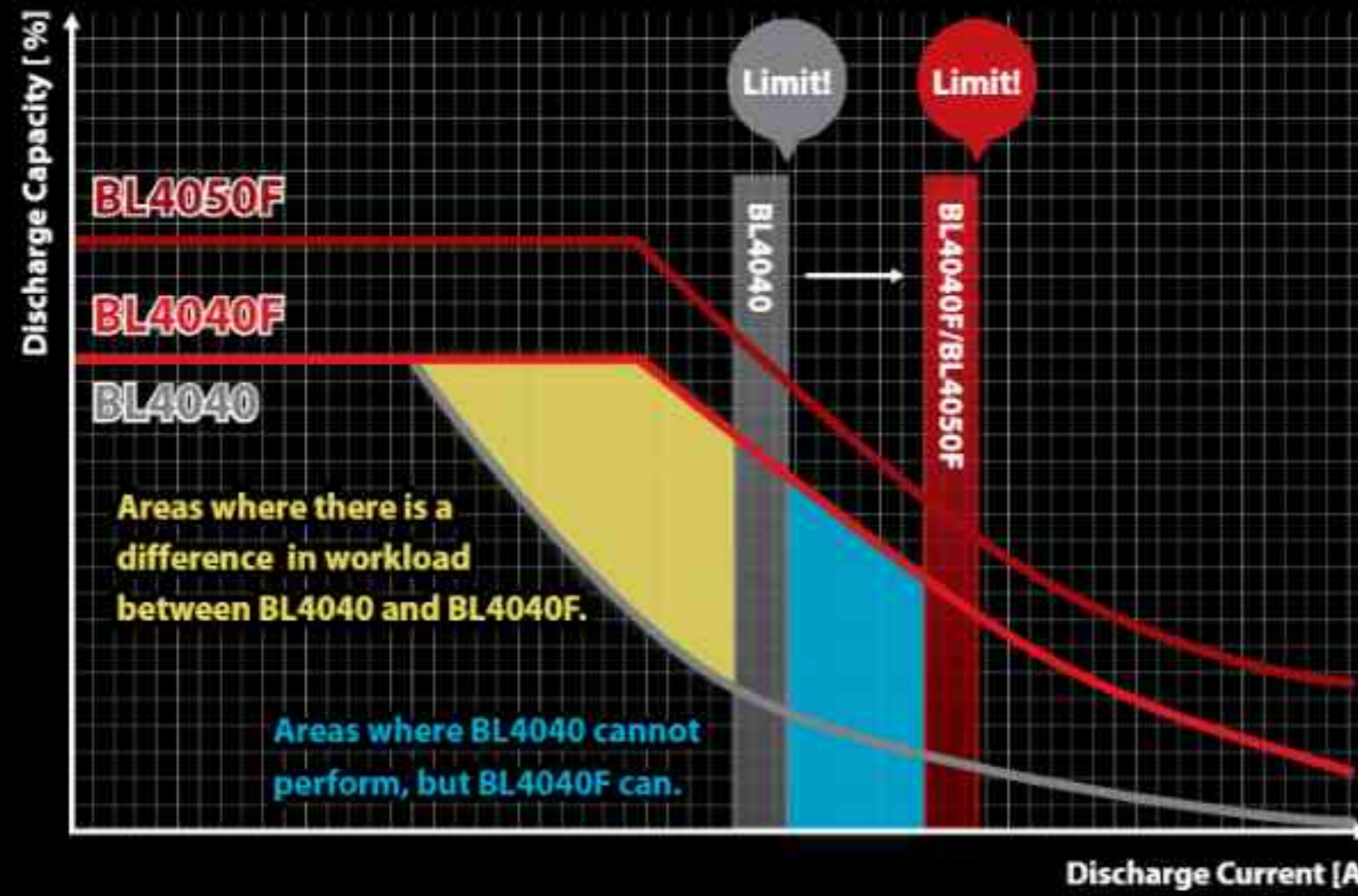

Cordless Chain Saw  
UC017G (42cc Class)  
Cutting ø300mm cedar log

Standard [BL4040]	9.7 sec.
High Output Battery [BL4040F / BL4050F]	6.9 sec. <b>UP TO 29% FASTER</b>



## Demonstrates tenacity even under heavy load.

By using the high output battery, it is less likely to slow down under heavy load, demonstrating tenacity and leading to increased efficiency. Despite having the same battery capacity, the work output per charge with the BL4040F can be higher than the BL4040 under high load conditions.

Cordless Angle Grinder  
GA050G (125 mm/5")

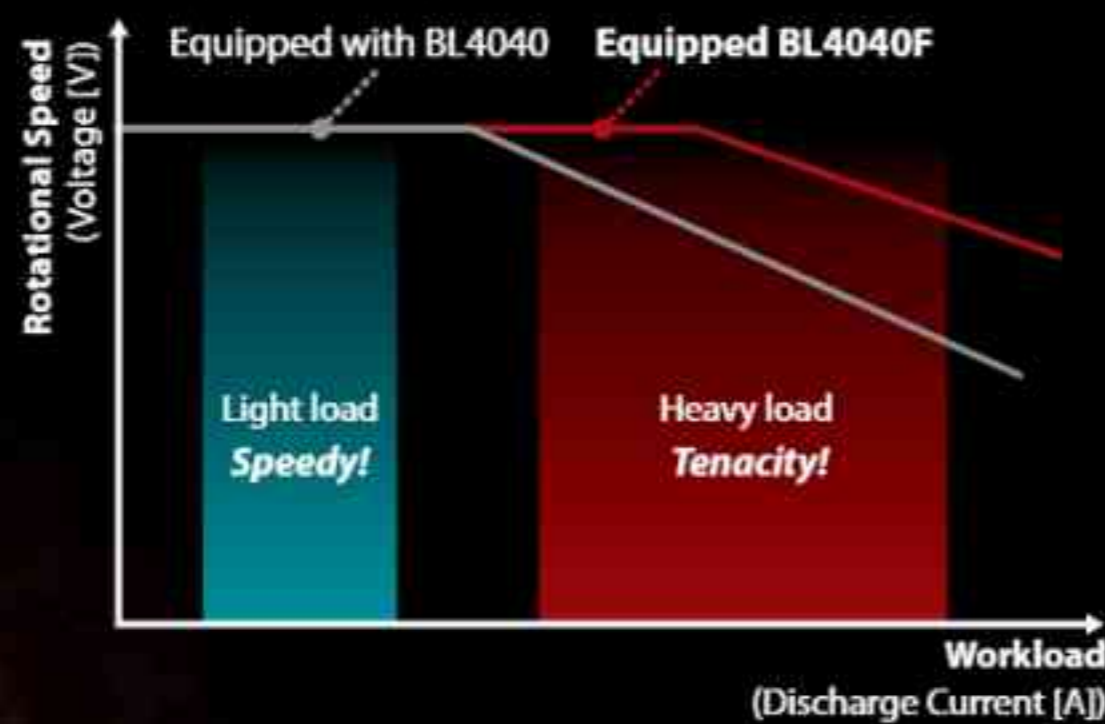

Cordless Angle Grinder  
GA038G (230mm/9")  
Cutting concrete continuously at depth of 40mm

Work amount per charge

Standard [BL4040]	240 cm
High Output Battery [BL4040F / BL4050F]	410 cm <b>UP TO 71% LONGER</b>

Achieves increased continuous output performance under heavy load, which is equivalent to BL4050F, while maintaining the same size as BL4040.



vs BL4040

 **36%**  
MORE POWER

 **32%**  
COOLER

vs BL4050F

 **28%**  
LESS WEIGHT

 **32%**  
MORE COMPACT



# 40V Li-ion max

High Power

Durability

Digital Communication



Rotary Hammer



Demolition Hammer



Power Cutter



Breaker



Grass Trimmer



Vacuum Cleaner

### Battery

BL4020  
2.0Ah

BL4025  
2.5Ah

BL4040 /  
BL4040F  
4.0Ah





Impact Driver

Driver Drill

Hammer Driver Drill

Rotary Hammer

Demolition Hammer

Combination Hammer

Brad Nailer

Shear Wrench

Air Compressor

Impact Wrench

Angle Drill

Polisher

Earth Auger

Mixer

Concrete Vibrator

Rear Handle Saw

Communication connector



230+ TOOLS

Angle Grinder

Belt Sander

Multi Tool

Orbital Sander

Random Orbit Sander

Metal Cutter

Power Cutter

Hole Puncher

Plunge Cut Saw

Jig Saw

Slide Compound Miter Saw

Dust Blower

Circular Saw

Planer

Polisher Scrubber

Recipro Saw

Portable Band Saw

High Pressure Washer

Backpack Vacuum Cleaner

Upright Cleaner

Trimmer

Router

Vacuum Sweeper

Vacuum Cleaner

Cleaner

Charger

BL4050F 5.0Ah

BL4080F 8.0Ah

DC40RA

DC40RB

DC40WA

DC40RC

ADP10



Adapter for LXT Battery





Chain Saw

Pole Saw

Grass Trimmer

Lawn Mower

Pruning Shears

Earth Auger

Vacuum Pump

High Pressure Washer

Wheelbarrow

Kettle

Portable Power Pack

Impact Wrench

Blower

Vacuum Cleaner

Multi Function Power Head

Mixer

Concrete Vibrator

4 Mode Impact Driver

18V x2

Auto Feed Screwdriver

Oil-Pulse Driver

Driver Drill

Angle Drill

Angle Impact Wrench

Screwdriver

Impact Driver

# 430+ TOOLS

6.0Ah 5.0Ah 4.0Ah  
3.0Ah 2.0Ah 1.5Ah

Angle Impact Driver

Ratchet Wrench

Impact Driver

Hammer Driver Drill

Rotary Hammer

Die Grinder

Sander Polisher

Power Scraper

Combination Hammer



ReciproSaw

Steel Rod Cutter

Multi Tool

Finishing Sander

Angle Grinder

Metal Shear

Drywall Sander

Random Orbit Sander



Compound Miter Saw

Threaded Rod Cutter

Compact Cut Off

Belt Sander

Nibbler

Cable Cutter

Metal Cutter

Portable Band Saw

Cutter

Slide Compound Miter Saw

## Expand Your Lithium Line Up

# A wide variety of Lithium-ion Garden

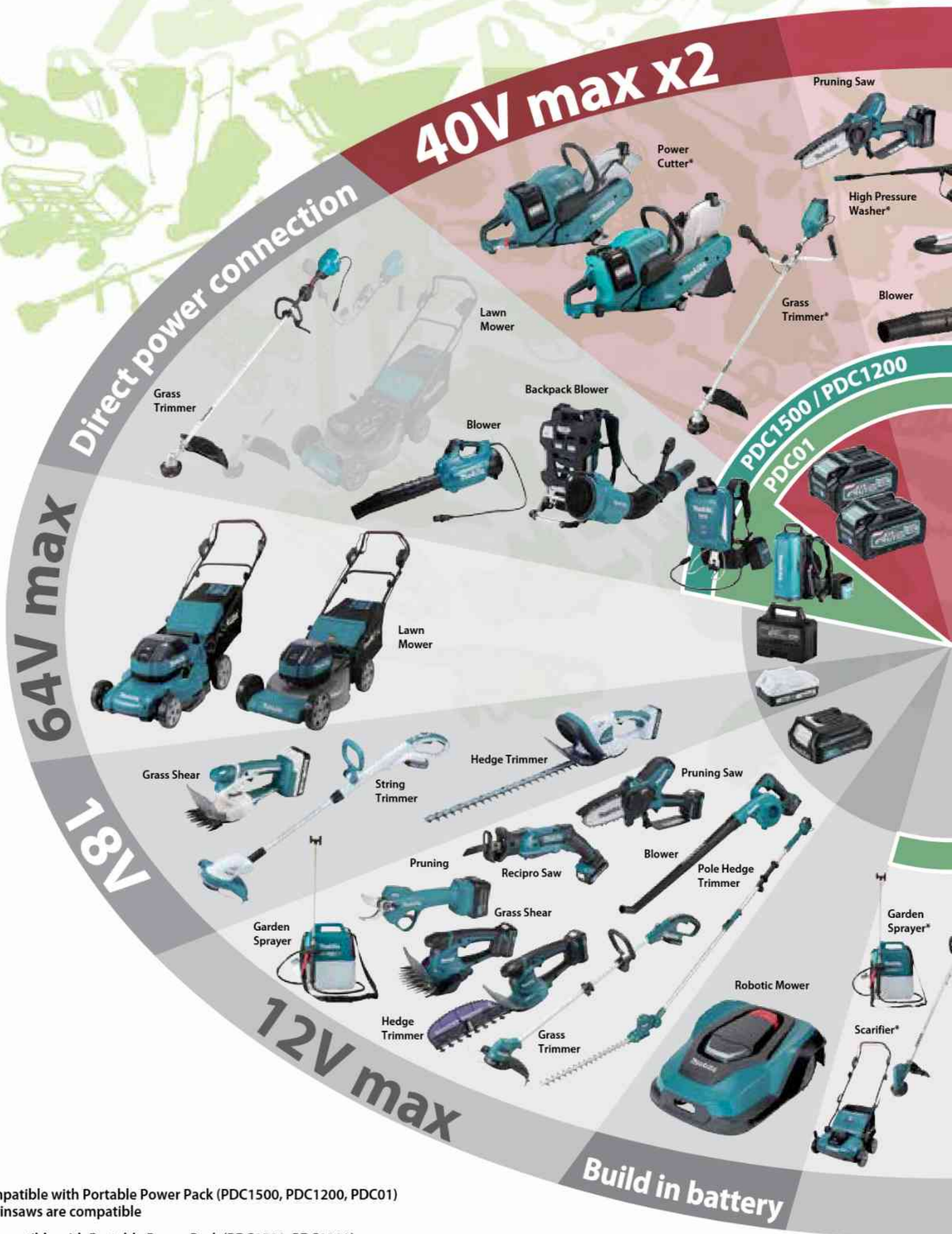

\* These models are not compatible with Portable Power Pack (PDC1500, PDC1200, PDC01)  
Only rear handle type chainsaws are compatible

\*\* These models are not compatible with Portable Power Pack (PDC1500, PDC1200)

\*\*\*This model is not compatible with Portable Power pack (PDC1500)

# Green Tools

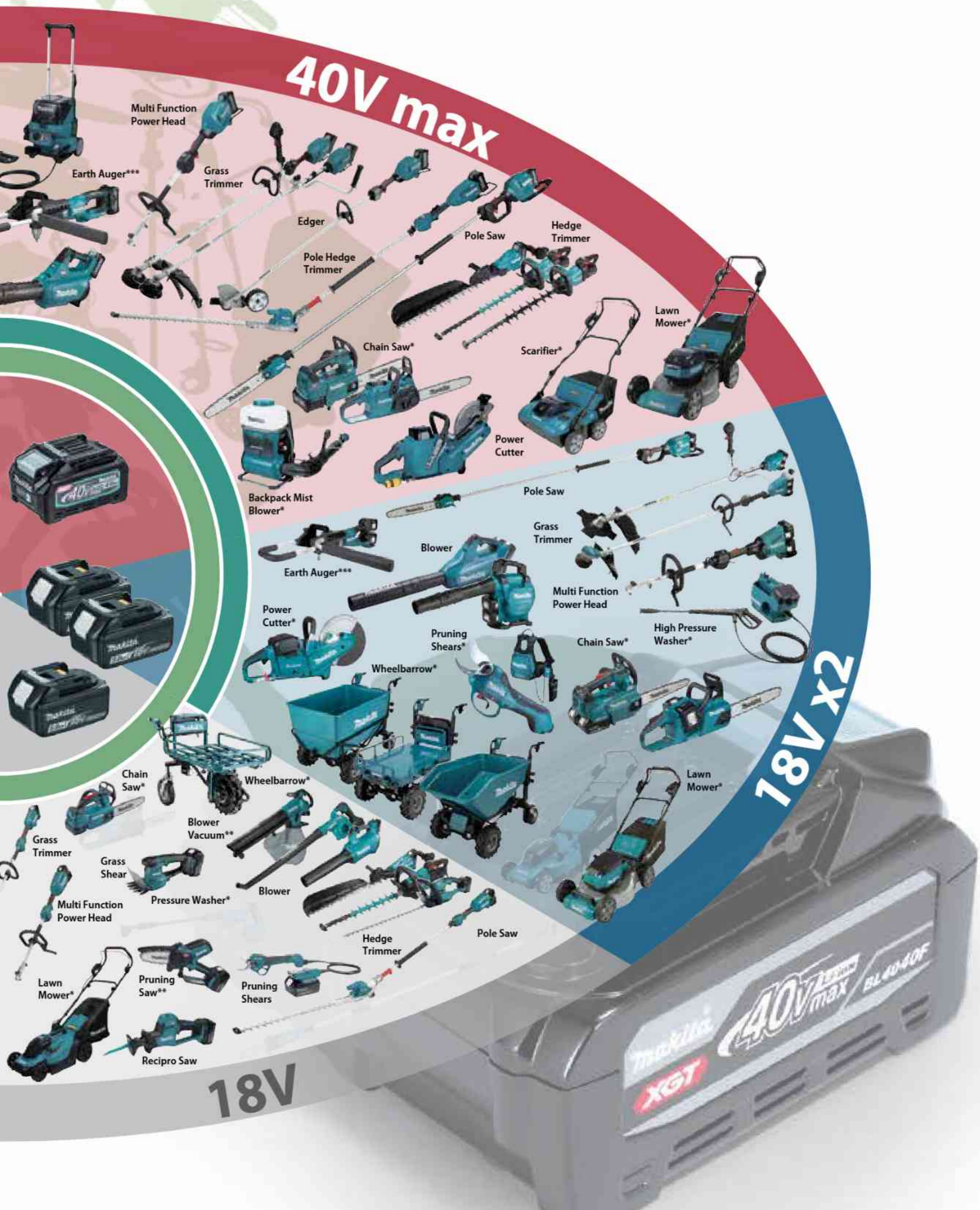

40V max

18V x2

18V

Multi Function Power Head

Earth Auger\*\*\*

Grass Trimmer

Edger

Pole Hedge Trimmer

Pole Saw

Hedge Trimmer

Chain Saw\*

Scarifier\*

Lawn Mower\*

Power Cutter

Backpack Mist Blower\*

Pole Saw

Earth Auger\*\*\*

Blower

Grass Trimmer

Power Cutter\*

Pruning Shears\*

Multi Function Power Head

High Pressure Washer\*

Wheelbarrow\*

Chain Saw\*

Chain Saw\*

Wheelbarrow\*

Lawn Mower\*

Grass Trimmer

Blower Vacuum\*\*

Grass Shear

Pressure Washer\*

Blower

Multi Function Power Head

Hedge Trimmer

Pole Saw

Lawn Mower\*

Pruning Saw\*\*

Pruning Shears

Recipro Saw

Makita 40V max BL40-60F XGT

# 12V<sub>max</sub> LITHIUM-ION

**90+ TOOLS**

4.0Ah 2.0Ah 1.5Ah

EXPAND YOUR LITHIUM-ION LINEUP



# Portable Power Pack

## PDC1500

**Powered by 36V-40Vmax built-in battery**  
1,500Wh-class high capacity

**IPX4**

Charger: DC4001  
Charging time: 450 min

## PDC1200

**Powered by 36V-40Vmax built-in battery**  
1,200 Wh high capacity

**IPX4**

Charger: DC4001  
Charging time: 360 min

## PDC01

**Powered by up to four 18V LXT batteries**  
432 Wh high capacity  
(with 4 pcs. of BL1860B)

**IPX4**

### Battery Powered Models

UR101C  
UR201C  
UR202C

LM001C

UB003C

UB004C

VR001C  
VR003C  
VR004C

### Adapter set + XGT 40Vmax

### Adapter set + 18v + 18v → 36v

### Adapter set + 18V LITHIUM-ION

## Features and benefits (PDC1500 / PDC1200)



### Height-adjustable waist belt

The position of the waist belt can be adjusted for personal fit and comfort.



### Quickly removable harness

can be attached / removed from the main unit with a single action.



### Reflectors

keep operator visible from a distance even in the dark.

## PDC1500 / PDC1200 / PDC01 Portable Power Pack

	PDC1500	PDC1200	PDC01
Capacity	43.55 Ah	33.5 Ah	24 / 12 Ah
Energy capacity	1,567.8 Wh	1,206 Wh	432 Wh (BL1860Bx4)
Number of cells	130	100	-
Charging time (hours)	7.5	6	-
Power supply cord	Battery side: 1.2 m (3.9 ft) Adapter side: 0.6 m (2.0 ft)	Battery Side: 1.1 m (3.6 ft) Adapter Side: 0.6 m (2.0 ft)	1.7 m (5.6 ft)
Dimensions (L x W x H)	w/o Harness: 369 x 312 x 131 mm (14-1/2 x 12-1/4 x 5-1/8") w/ Harness: 516 x 312 x 193 mm (20-1/4 x 12-1/4 x 7-5/8")	w/o Harness: 369 x 261 x 139 mm (14-1/2 x 10-1/4 x 5-1/2") w/ Harness: 428 x 261 x 164 mm (16-7/8 x 10-1/4 x 6-1/2")	w/o Harness: 400 x 195 x 132 mm (15-3/4 x 7-5/8 x 5-3/16") w/ Harness: 400 x 270 x 149 mm (15-3/4 x 10-5/8 x 5-7/8")
Net weight	11.1 - 13.0 kg (24.5 - 28.7 lbs.)	8.8 kg (19.4 lbs.)	2.8 kg (6.1 lbs.)

Harness, Charger

PDC1500A01 - Rs. 2,71,020

Harness, Adapter for 36V (18V x2) [countries-specific], Charger

PDC1200A01 - Rs. 2,13,980

Harness, Adapter

PDC01 (191A62-6) - Rs. 63,080

# Rapid Optimum Charging System

It is necessary to cool down before start charging when the battery temperature is high. Built-in fan circulates air through the battery before start charging and during the charging process to cool the battery for faster charge time.

The Makita Rapid Optimum Charger communicates with the battery's built-in chip throughout the charging process to optimize battery life by actively controlling current, voltage and temperature.



## The optimum charging system



## General charging method



## The optimum charging system

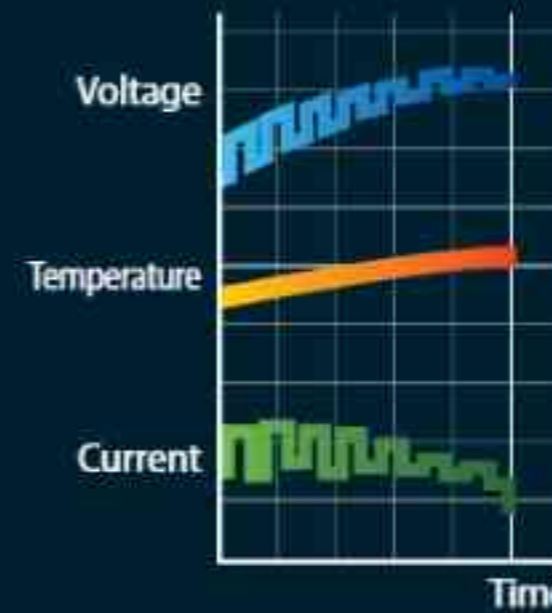

## General charging method

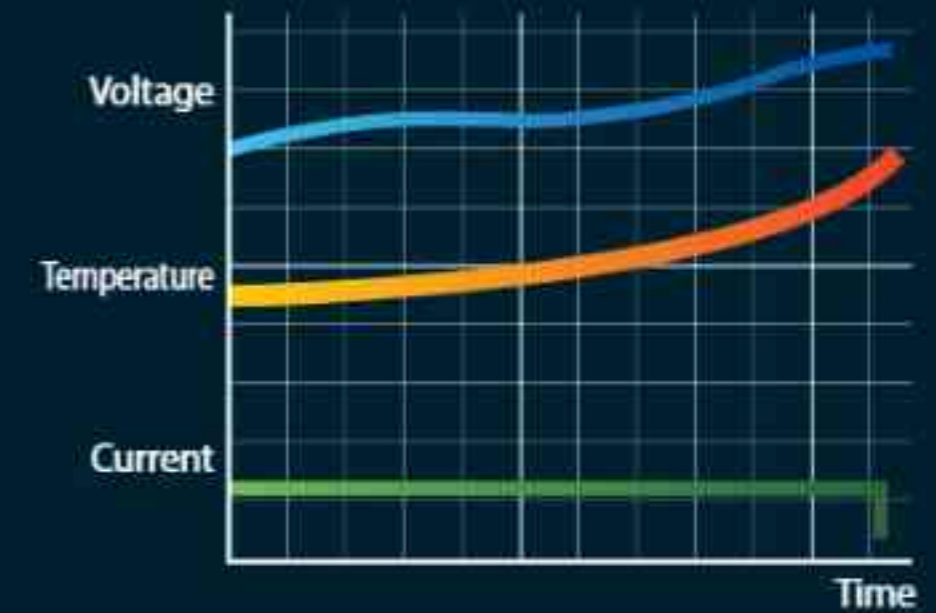

# Li-ion Battery & Charging Time Reference, Compatibility Chart

		40Vmax 18V	Fast Charging DC40RA DC40RB*1	DC40RC	DC40WA*1	Fast Charging DC40RA + ADP10 Compatible with LXT Li-Ion batteries	DC40RC + ADP10 Compatible with LXT Li-Ion batteries	Fast Charging DC18RC DC18RD*1 DC18RE*2	DC18SF Except BL1430A	DC18SD DC18SH*1 DC18SE (Automotive)	DC18WC	
40Vmax Lithium-ion XGT	8.0Ah BL4080F		76min.	170min.	420min.	-	-	-	-	-	-	
	5.0Ah BL4050F		50min.	85min.	260min.	-	-	-	-	-	-	
	4.0Ah BL4040F BL4040		45min.	67min.	210min.	-	-	-	-	-	-	
	2.5Ah BL4025		28min.	38min.	130min.	-	-	-	-	-	-	
	2.0Ah BL4020		22min.	30min.	110min.	-	-	-	-	-	-	
18V Lithium-ion LXT	6.0Ah BL1860B		-	-	-	40min.	85min.	55min.	1 to 2 batteries 130 min.	3 to 4 batteries 260 min.	130min.	160min.
	5.0Ah BL1850B		-	-	-	35min.	70min.	45min.	110 min.	220 min.	110min.	135min.
	4.0Ah BL1840B		-	-	-	29min.	58min.	36min.	90 min.	180 min.	90min.	110min.
	3.0Ah BL1830B		-	-	-	22min.	42min.	22min.	60 min.	120 min.	60min.	80min.
	2.0Ah BL1820B		-	-	-	24min.	33min.	24min.	45 min.	90 min.	45min.	55min.
	1.5Ah BL1815N		-	-	-	15min.	22min.	15min.	30 min.	60 min.	30min.	40min.

\*1 DC40RB / DC40WA / DC18RD / DC18SH: Two Port Multi Charger \*2 DC18RE: CXT & LXT Dual port Fast Charger



**Battery Charging Case  
BCC01 / BCC02**

**With multiple charging ports for 40Vmax XGT Li-Ion batteries**

**BCC01: 8 ports**



**BCC02: 12 ports**



**Switch charging of batteries attached to multiple ports**

Capable of charging all batteries on four ports simultaneously. Equipped with a feature that automatically switches batteries to charge them.



**18V batteries can be charged using an adapter  
BCC01 only**



**Li-ion Battery & Charging Time Reference, Compatibility Chart**

12V max Lithium-ion		Fast Charging DC105B DC18RE**	DC10WD	PDC1200	PDC1500	DC4001	PDC01			
CXT	5.0Ah BL1050B	75min.	160min.	40V max Lithium-ion	35.5Ah PDC1200	360min.	40V max Lithium-ion 18V x2 Lithium-ion 18V Lithium-ion			
	4.0Ah BL1041B	60min.	130min.		43.55Ah PDC1500			450min.		
	2.0Ah BL1021B	30min.	70min.							
	1.5Ah BL1016	22min.	50min.							
64V max Lithium-ion		DC64WA	10.8V	7.2V	DC10WA	DC10WB	18V	DC18WA	DC18WB	
CXT	10.0Ah BL64100	300min.	10.8V Lithium-ion	1.5Ah BL1015K	55min.	55min.	18V Lithium-ion	1.5Ah BL1815G	70min.	80min.
	4.0Ah BL6440	120min.	7.2V Lithium-ion	1.5Ah BL0715	35min.	35min.		2.0Ah BL1820G	90min.	105min.

\*\*2 DC18RE: CXT & LXT Dual port Fast Charger



**Power Converter  
BAC01**

**Power converter powered by Makita portable power pack  
(BAC01 + PDC1200 / PDC1500)**

The device, which converts DC power into AC power, is optimal for a wide range of applications.

**AC output** | 50/60 Hz switchable with pure sine wave

Max output  
Rating value for 4 seconds  
**2,800 W(VA)**  
Continuous rating output  
**1,400 W(VA)**

**Output port**

- AC output\*<sup>3</sup> x2
- USB output Type-A x2
- USB output Type-C x2
- DC output 12V/10A Cigar socket

\*<sup>3</sup> Output voltage and outlet shape vary depending on the country.

# High capacity for longer run-time & all-day work

## Tools with Portable Power Pack PDC1200



191N62-4 (XGT Adaptor)



Charger



**Brushless Cordless Multi Function Power Head - UX01G**  
 UX01GZX001 - Rs. 2,83,320

**new**

**XGT BL AFT XPT**

**40V max** Pipe/Wd: 130/255mm, 3,000 spm, 12.6kg



**Brushless Cordless Grass Trimmer - UR006G**  
 UR006GX001 - Rs. 2,99,000

**new**

**XGT BL ADT AFT WG XPT**

**40V max** 4,600 RPM, 6.3 kg

**Brushless Cordless Impact Wrench - TW001G**  
 TW001GX001 - Rs. 2,94,990

**new**

**XGT BL XPT**

**40V max** M12/M36, 1,800 N-m, 1,800 rpm, 4.2 kg

**Brushless Cordless Impact Wrench - TW010G**  
 TW010GX001 - Rs. 3,53,320

**new**

**XGT BL XPT**

**40V max** 4,000 N-m, 1,200 RPM, 12.8 kg

**Brushless Cordless Blower - UB001G**  
 UB001GX002 - Rs. 2,76,650

**XGT BL**

**40V max** 23,000 RPM, 3.9 kg

# Screwing / Drilling

## Brushless Cordless Driver Drill - DF001G



DF001GD201 - Rs. 87,950  
DF001GZ - Rs. 36,910

XGT BL MOTOR XPT AFT

40V max st/wd:20/50mm, 125 N-m 2600 rpm, 3.0 kg

## Brushless Cordless Driver Drill - DF002G



DF002GD201 - Rs. 74,910  
DF002GZ - Rs. 23,770

XGT BL MOTOR XPT

40V max st/wd: 13/18mm, 65 N-m, 2200 rpm, 2.5 kg

## Cordless Driver Drill - DDF482



DDF482RFE - Rs. 34,380  
DDF482RFX1 - Rs. 30,000  
DDF482Z - Rs. 11,750

LXI XPT

18V St/Wd:13/38mm, 62 N-m, 1900 rpm, 1.5kg

## Cordless Driver Drill - DDF458



DDF458RFE - Rs. 49,010  
DDF458Z - Rs. 29,320

LXI XPT

18V St/Wd:13/76mm, 84 N-m, 2000 rpm, 2.5kg

## Brushless Cordless Driver Drill - DDF485



DDF485RFE - Rs. 41,800

LXI BL MOTOR XPT

18V St/Wd:13/36mm, 50 N-m, 1900 rpm, 1.7kg

## Brushless Cordless Driver Drill - DDF486



DDF486RTE - Rs. 67,470  
DDF486Z - Rs. 30,680

LXI BL MOTOR XPT

18V 2.5 m/s<sup>2</sup> or less / 0 - 2100 rpm, 2.6 kg

## Brushless Cordless Driver Drill - DDF487



DDF487RFJ - Rs. 49,010  
DDF487Z - Rs. 19,650

LXI BL MOTOR XPT

18V 2.5 m/s<sup>2</sup> or less / 0 - 1,700 rpm, 1.6 kg

## Brushless Cordless Driver Drill - DDF484



DDF484RFE - Rs. 51,450  
DDF484Z - Rs. 24,750

LXI BL MOTOR XPT

18V St/Wd:13/38mm, 54 N-m, 2000 rpm, 1.8kg

## Brushless Cordless Driver Drill - DDF489



DDF489RTJ - Rs. 67,900  
DDF489Z - Rs. 37,140

LXI BL MOTOR XPT

18V 2.5 m/s<sup>2</sup> or less, 1800 rpm 2.5 kg

## Cordless Driver Drill - DF488D



DF488D002 - Rs. 25,050

G-Battery

18V 1.5 - 13 mm, 1,400 rpm, 1.7 kg

## Brushless Cordless Driver Drill - DDF083



DDF083RFE - Rs. 46,680  
DDF083Z - Rs. 19,490

LXI BL MOTOR XPT

18V St/Wd:13/36mm, 40 N-m, 1700 rpm, 1.4kg

## Cordless Driver Drill - DF333D



DF333DWY - Rs. 13,580

CXI

12V max S/W: 10/21mm, 30 N-m, 1700 rpm, 1.2kg

## Brushless Cordless Driver Drill - DF332D



DF332DWYE - Rs. 21,000

CXI BL MOTOR XPT

12V max S/W: 10/28mm, 35 N-m, 1500 rpm, 1.2kg

## Brushless Cordless Driver Drill - DF032D



DF032DWYE - Rs. 24,500  
DF032DZ - Rs. 13,590

CXI BL MOTOR XPT

12V max S/W: 10/28mm, 35 N-m, 1500 rpm, 0.88kg

## Cordless Driver Drill - DF030D



DF030DWE - Rs. 16,660

10.8V 1,300 min<sup>-1</sup>, 28 N-m, 0.88 kg

## Cordless Driver Drill - DF012D



DF012DSE - Rs. 23,320

7.2V S/W: 5/6mm, 5.6 N-m, 650 rpm, 0.53kg

## Driver Drill - DF0300



411  
Rs. 9,140

320W, 1500 rpm, 1.2kg

## Brushless Cordless Hammer Driver Drill - HP001G



HP001GD201 - Rs. 89,040  
HP001GZ - Rs. 38,090

XGT BL MOTOR XPT AFT

40V max st/wd: 20/50mm, 125 N-m, 2,600 rpm, 3.0 kg

## Brushless Cordless Hammer Driver Drill - HP002G



HP002GD201 - Rs. 74,910  
HP002GZ - Rs. 23,770

XGT BL MOTOR XPT

40V max 0 - 9,000 IPM, 0 - 600 RPM 2.6 kg

## Cordless Hammer Driver Drill - DHP458



DHP458RFE - Rs. 53,560

LXI XPT

18V S/W/M: 13/76/13mm, 30000 ipm, 2000 rpm, 2.6kg

### Cordless Hammer Driver Drill - DHP482

13mm



DHP482RFE - Rs. 36,810  
DHP482RME - Rs. 35,000  
DHP482SFX8 - Rs. 25,890  
DHP482Z - Rs. 12,750

**LXI XPT**

18V S/W/M: 13/38/13mm, 28500 ipm, 1900

### Brushless Cordless Hammer Driver Drill - DHP484

13mm



DHP484RFE - Rs. 51,450  
DHP484Z - Rs. 27,490

**LXI BL XPT**

18V S/W/M: 13/38/13mm, 30000 ipm, 2000 rpm, 1.9kg

### Brushless Cordless Hammer Driver Drill - DHP485

13mm



DHP485Z - Rs. 18,490

**LXI BL XPT**

18V S/W/M: 13/36/13mm, 28500 ipm, 1900 rpm, 1.8kg

### Brushless Cordless Hammer Driver Drill - DHP486

13mm



DHP486RTE - Rs. 68,630  
DHP486Z - Rs. 31,930

**LXI BL XPT**

18V 0 - 31,500 IPM 0 - 2,100 RPM 2.7 kg

### Brushless Cordless Hammer Driver Drill - DHP487

13mm



DHP487RFJ - Rs. 44,040  
DHP487YX2B - Rs. 36,930  
DHP487SYX2 - Rs. 36,930  
DHP487Z - Rs. 17,820

**LXI BL XPT**

18V 0 - 25,500 IPM 0 - 1,700 RPM 1.7 kg

### Brushless Cordless Hammer Driver Drill - DHP489

13mm



DHP489RTJ - Rs. 68,980  
DHP489Z - Rs. 38,200

**LXI BL XPT**

18V 27,000 ipm, 1,800 rpm, 2.5 kg

### Cordless Hammer Driver Drill - HP331D

10mm



HP331DWYE - Rs. 16,000

**CXI**

12V max S/W/M: 10/21/8mm, 28 N-m, 25500

### Cordless Hammer Driver Drill - HP488D

13mm



HP488D002 - Rs. 27,370

G-Battery

18V 47 N-m (420 in.lbs), 230 W, 1.8 kg

### Hammer Driver Drill - HP0300

10mm



Rs. 9,670

320W, 1500 rpm, 22,500 bpm, 1.3kg

### Brushless Cordless Impact Driver - TD003G

6.35



TD003GA201 - Rs. 61,550  
TD003GZ - Rs. 31,830

**XGT BL XPT**

40V max 210 N.m 3,700 rpm, 4,100 ipm 2.9 kg

### Brushless Cordless Impact Driver - TD002G

6.35



TD002GD202 - Rs. 82,400  
TD002GZ01 - Rs. 38,110

**XGT BL XPT**

40V max M4 - M8, 220 N-m, 3,700 rpm, 2.9 kg

### Brushless Cordless Impact Driver - TD001G

6.35



TD001GM201 - Rs. 87,950  
TD001GD201 - Rs. 74,000  
TD001GZ - Rs. 35,500

**XGT BL XPT**

40V max M8/M16, 220 N-m, 3,700 rpm, 2.0 kg

### Brushless Cordless Impact Driver - DTD172

1/4"



DTD172RTJ - Rs. 61,800  
DTD172Z - Rs. 27,350

**LXI BL XPT**

18V M4/M8, 180 N.m, 3,600 ipm, 3000

### Brushless Cordless Impact Driver - DTD173

180



DTD173RTJ - Rs. 60,820  
DTD173Z - Rs. 27,490

**LXI BL XPT**

18V M4/M8, 180 N.m, 38 mm (1-1/2"), 1.5

### Brushless Cordless Impact Driver - DTD157

6.35 mm



DTD157RTJ - Rs. 55,180  
DTD157Z - Rs. 16,430

**LXI BL XPT**

18V 140 N.m IPM 0 - 3,000 RPM 1.5 kg

### Cordless Impact Driver - DTD156

1/4" Hex



DTD156RFE - Rs. 38,320  
DTD156SFE - Rs. 37,140  
DTD156Z - Rs. 8,710

**LXI**

18V M8/M14, 155N.m 2,500 rpm, 1.6 kg

### Brushless Cordless Impact Driver - DTD153

170



DTD153Z - Rs. 19,650

**LXI BL XPT**

18V 170 N.m, 107 dB(A), 1.6kg

### Brushless Cordless Impact Driver - DTD154

1/4"



DTD154RFE - Rs. 54,010  
DTD154Z - Rs. 23,650

**LXI BL XPT**

18V M8/M16, 175 N.m, 3800 ipm, 3600

### Cordless Impact Drill - TD110D

1/4"



TD110DWYE - Rs. 18,460  
TD110DZ - Rs. 6,780

**CXI**

12V max S/B M5/M12, 110 N-m, 2600 rpm,

### Brushless Cordless Impact Drill - TD111D

1/4"



TD111DWYE - Rs. 27,040  
TD111DZ - Rs. 16,040

**CXI BL XPT**

12V max S/B M5/M14, 135 N-m, 3000 rpm,

### Cordless Impact Driver - TD090D

6 mm



TD090DZ - Rs. 10,990

10.8V M4 - M8 mm, 90 N-m, 2,400 rpm, 3000

**Cordless Impact Driver - TD022D** 411

1/4" TD022DSE - Rs. 21,020



7.2V M8 / M6, 25 N-m, 2450 rpm, 3000

**Impact Driver - TD0101** 411

Rs. 10,390



1600W, 5500 rpm, 4.0kg

**High Speed Drill - DP2010** 419

6.5mm Rs. 7,540



370W, 4200 rpm, 1.0 kg

**Drill - DP4020**

13 mm DP4020 - Rs. 7,820



0 - 3,000 min<sup>-1</sup> 630W, 1.9 kg

**Drill - DP4021**

13 mm DP4021 - Rs. 8,320



Keyless drill chuck (2-sleeve)

0 - 3,000 min<sup>-1</sup> 630W, 1.6 kg

**2-Speed Drill - DP4010** 419

13mm DP4010 - Rs. 15,820



720W, 1200-2900 rpm, 2.3 kg

**Drill - 6412** 64

10mm Rs. 7,860



450W, 3400 rpm, 1.3 kg

**Brushless Cordless Angle Drill - DA001G**

13mm DA001GM101 - Rs. 1,01,850  
DA001GZ - Rs. 58,820



XGT BL ADT XPT

40V max 136N.m, 1,500 rpm, 6,2kg

**Cordless Angle Drill - DA332D**

10mm DA332DWAE - Rs. 28,230  
DA332DWYE - Rs. 18,000



12V max S/W: 10/12mm, 1100 rpm, 1.3kg

**Angle Drill - DA3010F** 419

10mm DA3010F - Rs. 29,930



1.5 - 10 mm (1/16 - 3/8"), 450W, 1.4 kg

**Cordless Angle Drill - DA333D**

10mm DA333DWAE - Rs. 27,060



12V max S/W: 10/12mm, 1100 rpm, 1.4kg

**Magnetic Drill - HB500** UD0EIB106C

50mm Rs. 1,99,670



350/650 rpm, 18.5 kg

**Brushless Cordless Angle Drill - DDA350**

10 mm DDA350Z new



18V 1.5 - 10 mm, 1,800 min<sup>-1</sup>, 1.5 - 1.8 kg

LXT

**Cordless Oil-Pulse Driver - DTS141**

6.35 DTS141Z - Rs. 33,340.00



18V 40 N-m, 3,200 min<sup>-1</sup>, 1.3 - 1.6 kg

LXT BL XPT

**Magnetic Drill - HB350** UD00EBD002

35mm Rs. 1,24,770



1,050W 8,000 N, 850 rpm, 11.5 kg

**Brushless Cordless Impact Wrench - TW010G**

1" (25.4) TW010GT201 - Rs. 1,85,320  
TW010GX001 - Rs. 3,53,320  
TW010GZ - Rs. 1,09,990 new



40V max 4,000 N-m, 1,200 RPM, 12.8 kg

XGT BL XPT

**Brushless Cordless Impact Wrench - TW009G**

1" (25.4) TW009GT201 - Rs. 1,79,490  
TW009GZ - Rs. 1,04,320 new



40V max 4,000 N-m, 1,200 RPM, 11.8 kg

XGT BL XPT

**Brushless Cordless Impact Wrench - TW007G**

1/2" (12.7) TW007GM204 - Rs. 1,07,750  
TW007GD202 - Rs. 99,990  
TW007GZ02 - Rs. 47,750  
TW007GZ - Rs. 39,200 new



40V max 760 N-m 2,900 IPM, 2,300 RPM 3.3 kg

XGT BL XPT

**Brushless Cordless Impact Wrench - TW004G**

1/2" (12.7) TW004GD201 - Rs. 84,460  
TW004GZ - Rs. 33,300



40V max M10/M20, 350 N-m, 3,200 rpm, 2.2 kg

XGT BL XPT

**Brushless Cordless Impact Wrench - TW003G**

1/2" TW003GM201 - Rs. 122,150  
TW003GZ - Rs. 50,990 new



40V max M12/M36, 1,600 N-m, 1,800 rpm, 5.1 kg

XGT BL XPT

**Brushless Cordless Impact Wrench - TW002G**

1/2" TW002GM201 - Rs. 1,22,150  
TW002GZ - Rs. 50,990 new



40V max M12/M36, 2,200 N-m, 1,800 rpm, 5.1 kg

XGT BL XPT

### Brushless Cordless Impact Wrench - TW001G

3/4" (19)

**new**

TW001GM204 - Rs. 1,22,030  
 TW001GD203 - Rs. 1,11,400  
 TW001GX001 - Rs. 2,94,990  
 TW001GM201 - Rs. 99,920  
 TW001GD201 - Rs. 91,670  
 TW001GZ02 - Rs. 50,920  
 TW001GZ - Rs. 48,810

**XGT BL XPT**

40V max M12/M36, 1,800 N-m, 1,800 rpm, 4.2 kg

### Brushless Cordless Impact Wrench - DTW1001

3/4" 19

DTW1001JX3 - Rs. 79,570  
 DTW1001ZX2 - Rs. 47,750

**LXI BL**

18V M30, 1050 N.m, 2200 ipm, 1800 rpm.

### Brushless Cordless Impact Wrench - DTW1002

1/2" (12.7)

DTW1002ZX2 - Rs. 46,110  
 DTW1002Z - Rs. 38,220

**LXI BL**

18V M30, 1000 N.m, 2200 ipm, 1800 rpm.

### Cordless Impact Wrench - DTW800

11.2

DTW800Z

**new**

**LXI BL**

18V 800 N-m, 24 m/s<sup>2</sup>, 3.4 - 3.7 kg

### Brushless Cordless Impact Wrench - DTW700

1/2" (12.7)

DTW700TJX1 - Rs. 79,570  
 DTW700ZX1 - Rs. 42,400

**LXI BL XPT**

18V 700 N.m 2,200 rpm, 2,700 ipm 2.7 kg

### Brushless Cordless Impact Wrench - DTW300

1/2" Hex

**new**

DTW300FJX5 - Rs. 65,360  
 DTW300RFJ - Rs. 63,320  
 DTW300RTJ - Rs. 55,700  
 DTW300ZX5 - Rs. 39,250  
 DTW300Z - Rs. 25,800

**LXI BL XPT**

18V 330.Nm, 3,200/0 rpm, 4,000/0 ipm 1.8

### Brushless Cordless Impact Wrench - DTW285

1/2"

DTW285ZJ - Rs. 28,320

**LXI BL XPT**

18V M20, 2,800rpm, 3,500ipm, 280 N-m,

### Cordless Impact Wrench - DTW190

1/2"

**new**

DTW190JX1 - Rs. 40,430  
 DTW190SFX7 - Rs. 25,890  
 DTW190Z - Rs. 14,990

**LXI**

18V M16, 190 N.m, 3000 ipm, 2300 rpm,

### Brushless Cordless Impact Wrench - DTW181

1/2"

**new**

DTW181RFE - Rs. 46,650  
 DTW181RTE - Rs. 52,720  
 DTW181Z - Rs. 16,040

**LXI BL XPT**

18V M16, 210 N.m, 3000 ipm, 2300 rpm,

### Cordless Impact Wrench - DTW180

9.5 mm

DTW180Z - Rs. 11,000

**LXI BL XPT**

18V 180 N-m, 1,300 min<sup>-1</sup>, 1.2 - 1.5 kg



### Cordless Impact Wrench - TW160D

3/8"

TW160DSAE - Rs. 30,680  
 TW160DZ - Rs. 18,460

**CXI BL**

12V max M16, 160 N-m, 2400 rpm, 3600 ipm,

### Cordless Impact Wrench - TW202D

12.7 mm

TW202D001 - Rs. 31,800  
 TW202DZ - Rs. 10,600

**LXI BL**

18V 200 N-m, 3,000 ipm, 2,300 rpm, 1.5 kg

### Impact Wrench - TW1000

25.4mm 1"

Rs. 84,880

**LXI**

1200W, M24-M30, 1500 ipm, 8.8 kg

### Impact Wrench - 6906

19mm 3/4"

Rs. 57,290

**LXI**

850W, M16-M22, 1600 ipm, 5.6 kg

### Impact Wrench - TW0350

12.7mm 1/2"

Rs. 29,720

**LXI**

400W, M12-M22, 2000 ipm, 3.0 kg

### Impact Wrench - TW0200

12.7mm 1/2"

Rs. 26,530

**LXI**

380W, M10-M16, 2200 ipm, 2.1 kg

### Cordless Ratchet Wrench - DWR180

9.5 / 6.35

DWR180RF - Rs. 39,250  
 DWR180Z - Rs. 19,650

**LXI XPT**

18V M5/M12, 47.5N.m 800 rpm, 1.6 kg

### Cordless Ratchet Wrench - WR100D

3/8"

WR100DWM - Rs. 29,490  
 WR100DZ - Rs. 18,460

**CXI XPT**

12V max M12, 47.5 N-m, 800 rpm, 1.2kg

### Cordless Angle Impact Wrench - DTL063

3/8"

DTL063Z - Rs. 25,240

**LXI**

18V M12, 16 N.m, 3000 ipm, 2000 rpm, 2.0

**Cordless Angle Impact Wrench - DTL061**

1/4" DTL061Z - Rs. 26,650

**new**



**LXT**

**18V** M4 - M12, 60 N.m, 3000 ipm, 2000

**Cordless Angle Impact Wrench - TL065D**

3/8" TL065DWYE - Rs. 40,430  
TL065DZ - Rs. 28,150



**CXT**

**12V max** M12, 60 N.m, 2000 rpm, 3000 ipm,



**Brushless Cordless Shear Wrench - WT001G**

WT001GT101 - Rs. 3,33,320  
WT001GZ - Rs. 2,86,650



**XGT BL XPT**

**40V max** 804 N.m, M16, M20, M225. 9 kg

**Brushless Cordless Shear Wrench - DWT310**

M22 DWT310ZK - Rs. 2,33,200



**18V x2** 14 rpm, 804 N.m, 6.5 - 7.1kg

**18V + 18V → 36V**

**LXT BL XPT**

**Diamond Core Drill - DBM230** EE73320225

230mm Rs. 2,27,320



**Stand P-54190**

2500 watts, 0-390/1040/1700 rpm, 37.5 kg

**Diamond Core Drill - DBM131** EE73320225

132mm Rs. 1,28,740



**Stand P-40082**

1700 watts, 1100-2300 rpm, 6.3 kg

**Shear Wrench - 6924N** 303

M22-M24 Rs. 3,03,420



1100N.m, 1330 watts, 19 rpm, 7.5 kg

**Screwdriver - FS2700** 419

230mm FS2700 - Rs. 17,820



570W, 2500 rpm, 1.8 kg

**In-Line Cordless Screwdriver - DF001D**

DF001DW - Rs. 8,710



**3.6V** 3.8mm, 4 N.m, 220 rpm, 0.36 kg

**Drilling Machine - TB131**

13mm Rs. 37,470



250W, 3,200rpm, 20kg

**Brushless Cordless Earth Auger - DG002G**

DG002GM101 - Rs. 1,16,600  
DG002GZ - Rs. 74,200



**XGT BL XPT ADT**

**40V max** 200 mm, 1,500 rpm 8.0 kg

**Brushless Cordless Earth Auger - DG001G**

DG001GM106 - Rs. 1,27,210  
DG001GZ06 - Rs. 80,620



**XGT BL XPT ADT**

**40V max** 0 - 1,500 / 0 - 400 8.1 kg

**Brushless Cordless Earth Auger - DDG461**

DDG461PT2 - Rs. 1,17,340  
DDG461Z - Rs. 76,930



**18V x2** 2.5 m<sup>2</sup> or less, 200 mm, 1,400 rpm 7.6 kg

**18V + 18V → 36V**

**LXT BL ADT XPT**

**Brushless Cordless Earth Auger - DDG460**

DDG460ZX8 - Rs. 76,500



**18V x2** 0 - 1,400 / 0 - 350 rpm 8.2 kg

**18V + 18V → 36V**

**LXT BL ADT XPT**



**BUILT-IN CLUTCH REDUCES GEAR DAMAGE BY AUTOMATICALLY DISENGAGING GEARS IF THE BIT BINDS**

## Stirring

### Brushless Cordless Concrete Vibrator - VR001G

VR001GZ - Rs. 25,030



XGT BL XPT

40V max

15,500 / 12,000 vpm, 7.8 kg



### Battery Powered Concrete Vibrator - VR001C

VR001CZ - Rs. 3,50,100



40V max

12,000 vpm, 11.8 kg

### Battery Powered Concrete Vibrator - VR002C

VR002CZ - Rs. 3,71,320



40V max

12,000 vpm, 12.9 kg

### Battery Powered Concrete Vibrator - VR003C

VR003CZ - Rs. 3,50,100



40V max

12,000 vpm, 12.6 kg

### Battery Powered Concrete Vibrator - VR004C

VR004CZ - Rs. 3,71,320



40V max

12,000 vpm, 13.7 kg

### Cordless Concrete Vibrator - DVR850

2.4 m

DVR850Z - Rs. 57,090



LXT

18V

2,400 mm (8 ft), 5.5 kg

### Brushless Cordless Mixer - UT001G

240 mm

UT001GM101 - Rs. 1,07,150

UT001GZ - Rs. 74,270



XGT BL XPT

40V max

1.5 m<sup>2</sup> / 0 - 920 rpm, 7.0 kg

## Hammer drilling / Chiselling

### Brushless Cordless Combination Hammer - HR008G

30 mm

HR008GM201 - Rs. 1,42,590

HR008GZ - Rs. 82,010



XGT BL AFT AWS AVT XPT

40V max

0 - 4,500 bpm, 0 - 840 rpm, 6.2 kg

### Brushless Cordless Combination Hammer - HR001G

28 mm

HR001GZ - Rs. 53,480

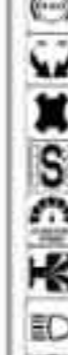

XGT BL AFT AWS AVT SOFT NOLOAD XPT

40V max

5,000 bpm, 980 rpm, 4.6 kg

### Brushless Cordless Combination Hammer - HR007G

28 mm

HR007GM201 - Rs. 1,02,280

HR007GZ - Rs. 43,600



XGT BL AFT AWS AVT XPT

40V max

0 - 5,000 bpm, 0 - 9,80 rpm, 4.8 kg

### Brushless Cordless Combination Hammer - HR003G

28 mm

HR003GM101 - Rs. 82,010

HR003GZ - Rs. 45,190

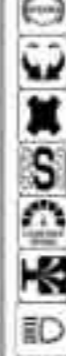

XGT BL AVT XPT

40V max

5,000 bpm, 980 rpm, 4.6 kg

### Brushless Cordless Combination Hammer - HR010G

28 mm

HR010GD201 - Rs. 98,130

HR010GZ - Rs. 36,070

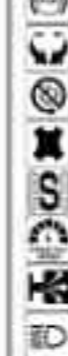

XGT BL AVT AWS XPT

40V max

5,000 bpm, 1,350 rpm, 4.5 kg

### Brushless Cordless Combination Hammer - DHR282

28 mm

DHR282PT2J - Rs. 91,880



LXT BL AFT AWS AVT XPT SOFT NOLOAD

18V x2

980 rpm, 5000 bpm, 5.0kg

18V + 18V → 36V

### Cordless Combination Hammer - DHR202

20 mm

DHR202RFE - Rs. 50,290



SDS-PLUS

18V

4000 bpm, 1100 rpm, 4 kg

LXT

### Cordless Combination Hammer - DHR241

20 mm

DHR241RFE - Rs. 49,010

DHR241SYE - Rs. 30,000



SDS-PLUS

18V

4000 bpm, 1100 rpm, 4 kg

18V + 18V → 36V

LXT

### Combination Hammer - HR2470

325

24 mm

HR2470 - Rs. 20,270



780W, 1100 rpm, 4500 ipm, 3.3 kg

### Combination Hammer - HR2810

325

28 mm

Rs. 36,810



800W, 1100 rpm, 4500 ipm, 3.8 kg

### Combination Hammer - HR2630

325

26 mm

Rs. 23,130



800W, 1200 rpm, 4600 ipm, 3.3 kg

**Combination Hammer - HR3001C** 350

30mm HR3001CJ - Rs. 49,440



0 - 4,500 BPM, 0 - 840 RPM, 4.5 kg

**Combination Hammer - HR3011FC** 350

30mm HR3011FCJ - Rs. 54,960



AVT

0 - 4,500 BPM, 0 - 840 RPM, 4.8 kg

**Combination Hammer - HR2670** 325

26mm HR2670 - Rs. 20,250



new

800W, 1,500 rpm, 4,500 bpm, 3.4 kg

**Combination Hammer - HR2670FT** 325

26mm HR2670FT - Rs. 28,320



new

800W, 1,500 rpm, 4,500 bpm, 3.4 kg

**Combination Hammer with Self Dust Collection - HR2652** 325

26mm Rs. 38,510



0 - 4,600 BPM, 0 - 1,200 RPM, 4.3 kg



**Brushless Cordless Rotary Hammer - HR006G**

52mm HR006GZ - Rs. 1,48,550



XGT X2 80Vmax

40V max x2 2,250 bpm, 310 rpm, 14.3 kg

**Brushless Cordless Rotary Hammer - HR005G**

40mm HR005GM201 - Rs. 1,60,190  
HR005GZ - Rs. 1,00,000



XGT BL AFT AWS AVT SOFT NOLOAD XPT

40V max 2,900 bpm, 500 rpm, 8.2 kg

**Brushless Cordless Rotary Hammer - DHR171**

17mm DHR171RTJ - Rs. 55,180  
DHR171Z - Rs. 21,650



SDS-PLUS LXI BL

18V 4800 bpm, 680 rpm, 2.8kg

**Brushless Cordless Rotary Hammer - DHR183**

18mm DHR183RTWJ - Rs. 81,700  
DHR183Z - Rs. 28,660



SDS-PLUS LXI BL AVT XPT

18V 0 - 5,000 bpm, 0 - 1,100 rpm, 2.9 kg

**Rotary Hammer - HR4013C** 350

40mm Rs. 79,700



AVT SOFT NOLOAD

1100W, 1450-2900 ipm, 6.9 kg

**Rotary Hammer - HR5202C** 175

52mm Rs. 1,01,650



1510W, 1100-2250 ipm, 11.1 kg

**Rotary Hammer - HR4002** 350

40mm Rs. 58,350



1050W, 680 rpm, 2500 ipm, 6.6 kg

**Brushless Cordless Demolition Hammer - HM002G**

SDS-MAX HM002GZ03 - Rs. 95,050



XGT X2 80Vmax

40V max x2 20.9 J, 1,900 bpm, 13.3 kg

**Brushless Cordless Demolition Hammer - HM001G**

SDS-MAX HM001GM202 - Rs. 1,22,420  
HM001GZ - Rs. 61,860



XGT BL AWS AVT SOFT NOLOAD XPT

40V max 9.4 J, 0 - 2,650 bpm, 7.1 kg

**Demolition Hammer - HM0870C** 350

SDS-MAX Rs. 50,730



7.6 J, 1100W, 1100-2650 ipm, 5.1 kg

**Demolition Hammer - HM1214C**

9.5mm HM1214C - Rs. 1,00,400



AVT SOFT NOLOAD

1,510W, 1,900 min<sup>-1</sup>, 8 m/s<sup>2</sup> 12.3 kg

**Rotary Hammer - HR2020** 419

20mm Rs. 18,360



710W, 1050 rpm, 4050 ipm, 2.3 kg

**Rotary Hammer - HR2230** 325

22mm HR2230 - Rs. 18,990



710W, 1050 rpm, 4050 ipm, 3.1 kg

**Rotary Hammer - HR4003C** 350

40mm Rs. 74,600



1100W, 1450-2900 ipm, 6.4 kg

**Demolition Hammer - HM1213C** 175

SDS-MAX Rs. 99,630



AVT SOFT NOLOAD

18.6 J, 1510W, 950-1900 ipm, 10.8 kg

Hammer drilling/  
Chiselling

Hammer drilling/  
Chiselling  
Grinding/Sanding/  
Polishing

**Demolition Hammer - HM1205CX1** 175

SDS-MAX HM1205CX1 - Rs. 87,860



19.1 J, 1510W, 950-1900 ipm, 9.7 kg

**Demolition Hammer - HM0810TA** 105

7.2 J HM0810TA - Rs. 44,040



2,900 min<sup>-1</sup>, 900W, 6.3 kg

**Demolition Hammer - HM1306** 204

Hex Shank Rs. 85,830



30mm, 21.7 J, 1510W, 1450 ipm, 15.1 kg

**Cordless Breaker - HM004G**

28.6 mm HM004GZ01 - Rs. 2,85,000



**XGT X2 80Vmax**  
**XGT AVT AWS SOFT NOLOAD XPT**

40V max x2 Impact energy 72.8 J, 32.1 kg

**Electric Breaker - HM1511** 218

Hex Shank Rs. 1,44,820



**AVT SOFT NOLOAD**

30mm, 48.9 J, 1,850W, 1,300 BPM, 19.2 kg

**Electric Breaker - HM1812** 218

Hex Shank HM1812 - Rs. 2,21,840



**AVT SOFT NOLOAD**

28.6mm, 72.8 J 2000W, 870 ipm, 31.3 kg

**Brushless Cordless Power Scraper - DHK180**

SDS-MAX DHK180Z - Rs. 54,650



**LXI BL AVT XPT**

18V 3.1 J / 3.9 J 0 - 3,200 bpm 3.6 kg

**Power Scraper - HK1820** 350

SDS-PLUS Rs. 57,190



550W, 3200 ipm, 3.4 kg

**2-Speed Hammer Drill - HP2070** 419

20mm Rs. 20,280



1010W, 1200-2900 rpm, 2.6 kg

**Hammer Drill - HP1630** 85

16mm HP1630 - Rs. 8,910



710W, 3200 rpm, 48000 ipm, 2.1 kg

**Grinding / Sanding / Polishing**

**Brushless Cordless Angle Grinder - GA003G**

100mm GA003GM201 - Rs. 87,950  
GA003GZ - Rs. 27,370



Slide switch  
**XGT BL AVT XPT**

40V max Side Grip, 8,500 rpm, 3.3 kg

**Brushless Cordless Angle Grinder - GA005G**

125mm GA005GM201 - Rs. 85,200  
GA005GZ - Rs. 28,000



Slide switch  
**XGT BL AVT XPT**

40V max Side Grip, 8,500 rpm, 3.6 kg

**Brushless Cordless Angle Grinder - GA013G**

125mm GA013GM201 - Rs. 92,730  
GA013GZ - Rs. 30,490



Paddle Switch  
**XGT BL AVT XPT**

40V max Side Grip, 8,500 rpm, 3.6 kg

**Brushless Cordless Angle Grinder - GA021G**

100mm GA021GM201 - Rs. 91,550  
GA021GD201 - Rs. 82,010  
GA021GZ - Rs. 30,980



Slide switch  
**XGT BL AVT AWS XPT**

40V max Side Grip, 8,500 rpm, 2.8 - 3.4 kg

**Brushless Cordless Angle Grinder - GA023G**

125mm GA023GM201 - Rs. 91,550  
GA023GD201 - Rs. 82,010  
GA023GZ - Rs. 30,980



Slide switch  
**XGT BL AVT AWS XPT**

40V max Side Grip, 8,500 rpm, 3.4 kg

**Brushless Cordless Angle Grinder - GA027G**

100mm GA027GM201 - Rs. 88,500  
GA027GD201 - Rs. 79,600  
GA027GZ - Rs. 33,300



Paddle Switch  
**XGT BL AVT AWS XPT**

40V max Side Grip, 8,500 rpm, 3.4 kg

**Brushless Cordless Angle Grinder - GA029G**

125mm GA029GM201 - Rs. 87,400  
GA029GD201 - Rs. 73,970  
GA029GZ - Rs. 32,160



Paddle Switch  
**XGT BL AVT AWS XPT**

40V max Side Grip, 8,500 rpm, 4.5 kg

**Brushless Cordless Angle Grinder - GA045G**

100mm GA045GM201 - Rs. 1,02,280  
GA045GZ - Rs. 41,590



Paddle Switch  
**XGT BL AVT XLock XPT**

40V max Side Grip, 8,500 rpm, 4.7 kg

**Brushless Cordless Angle Grinder - GA048G**

100mm GA048GT101 - Rs. 82,970  
GA048GZ - Rs. 41,380



Paddle Switch  
**XGT BL AVT XPT**

40V max 75 mm (3"), 11,000 rpm, 5.2 kg

**Brushless Cordless Angle Grinder - GA050G**

125mm GA050GT101 - Rs. 83,490  
GA050GZ - Rs. 41,910



Paddle Switch  
**XGT BL AVT XPT**

40V max 75 mm (3"), 11,000 rpm, 5.4 kg

**Brushless Cordless Angle Grinder - GA051G**

150mm  
GA051GT101 - Rs. 83,920  
GA051GZ - Rs. 42,320

Paddle Switch



**XGT BL AFT XPT**

40V max 75 mm (3"), 9,000 rpm, 4.7 kg

**Brushless Cordless Angle Grinder - GA047G**

125mm  
GA047GM201 - Rs. 1,02,280  
GA047GZ - Rs. 41,590

Paddle Switch



**XGT BL AFT XLock XPT**

40V max Side Grip, 8,500 rpm, 4.7 kg

**Brushless Cordless Angle Grinder - GA037G**

180 mm  
GA037GT201 - Rs. 1,09,990  
GA037GZ - Rs. 35,640

Paddle Switch



**XGT BL AFT AWS XPT**

40V max Side Grip, 7,800 rpm, 5.4 kg

**Brushless Cordless Angle Grinder - GA038G**

230mm  
GA038GZ - Rs. 38,090



**XGT BL AFT AWS XPT**

40V max Side Grip, 6,600 rpm, 7.4 kg

**Brushless Cordless Angle Grinder - GA035G**

150  
GA035GZ - Rs. 29,700

Slide switch



**XGT BL AFT XPT**

40V max 8,500 RPM 3.7 kg

**Brushless Cordless Angle Grinder - GA036G**

150  
GA036GZ - Rs. 32,160

Paddle Switch



**XGT BL AFT XPT**

40V max 8,500 RPM 3.7 kg

**Brushless Cordless Angle Grinder - DGA700**

180mm  
DGA700PT2 - Rs. 77,130  
DGA700Z - Rs. 34,320

18V + 18V → 36V



**LXI BL ADT AFT XPT**

18V x2 7800 rpm, 5.0 - 6.0 kg

**Brushless Cordless Angle Grinder - DGA901**

230mm  
DGA901PT2 - Rs. 83,400

18V + 18V → 36V



**LXI BL AWS ADT AFT XPT**

18V x2 6000 rpm, 5.2 - 8.0kg

**Brushless Cordless Angle Grinder - DGA404**

100mm  
DGA404Z - Rs. 22,990



**LXI BL ADT AFT XPT**

18V M10x1.5, 8,500 min<sup>-1</sup>, 2.71 kg

**Cordless Angle Grinder - DGA417**

100mm  
DGA417RTE - Rs. 61,220



**AFT ADT XPT BL**

18V Paddle Grip, 8500rpm, 2.9kg

**Brushless Cordless Angle Grinder - DGA413**

100mm  
DGA413RTE - Rs. 49,000



**LXI BL ADT AFT XPT**

18V Side Grip, 8500rpm, 2.8kg

**Brushless Cordless Angle Grinder - DGA411**

100mm  
DGA411RTE - Rs. 57,720  
DGA411Z - Rs. 24,990



**LXI BL ADT AFT XPT**

18V Side Grip, 8500rpm, 2.8kg

**Brushless Cordless Angle Grinder - DGA505**

125mm  
DGA505Z - Rs. 18,690



**LXI BL ADT AFT XPT**

18V Side Grip, 8500rpm, 3.73 kg

**Brushless Cordless Angle Grinder - DGA511**

125mm  
DGA511RTE - Rs. 57,720



**LXI BL ADT AFT XPT**

18V Side Grip, 8500rpm, 3.0kg

**Cordless Angle Grinder - DGA513**

125mm  
DGA513RTE - Rs. 60,050



**LXI BL AWS ADT AFT XPT**

18V Side Grip, 8500rpm, 3.0kg

**Brushless Cordless Angle Grinder - DGA419**

100 mm  
DGA419RTJ - Rs. 67,470



**LXI BL XPT XLock**

18V Side Grip, 8,500, rpm 3.0 kg

**Brushless Cordless Angle Grinder - DGA519**

125 mm  
DGA519RTJ - Rs. 69,920  
DGA519Z - Rs. 32,400



**LXI BL XPT XLock**

18V Side Grip, 8,500, rpm 3.1 kg

**Angle Grinder - GA5090**

125mm  
Rs. 27,580



**AFT SJS**

1,900W, 11,5,00 rpm, 3.8 kg

**Angle Grinder - GA5093**

125mm  
GA5093X03 - Rs. 31,830



**AFT SJS**

1,900W, 11,5,00 rpm, 4.0 kg

**Angle Grinder - GA5091**

125mm  
Rs. 31,830



**AFT SJS**

1,900W, 11,5,00 rpm, 4.0 kg

**Angle Grinder - GA5092**

125mm  
Rs. 25,480



**AFT SJS**

1,900W, 11,5,00 rpm, 5.7 kg

**Angle Grinder - GA5095** 264

125mm GA5095X04 - Rs. 26,530



**AFT** 

1,900W, 11,500 rpm, 3.8 kg

**Angle Grinder - 9565CR** 318

125mm Rs. 18,770





1400W, 12000 rpm, 2.4-3.5kg

**Angle Grinder - GA5040C** 318

125mm Rs. 22,990





1,400W, 2,800-11,000 min<sup>-1</sup>, 3.6 kg

**Angle Grinder - GA4050R** 260

100mm Rs. 19,300



1400W, 12000 rpm, 2.6 kg

**Angle Grinder - GA4040** 325

100mm Rs. 19,540





1100W, 11000 rpm, 2.5kg

**Angle Grinder - GA4040C** 318

100mm **new**





1,400W, 11000 rpm, 2.6 kg

**Angle Grinder - GA5010** 303

125mm GA5010 - Rs. 14,870



1050W, 12000 rpm, 3.8kg

**Angle Grinder - GA5080R**

125mm Rs. 27,920



**XLOCK**

1,400W, 12,000 rpm, 3.6 kg

**Angle Grinder - 9556HB** 325

100mm Rs. 8,810



840W, 11000 rpm, 2.0kg

**Angle Grinder - 9556HN** 325

100mm Rs. 7,990



840W, 11,000 min<sup>-1</sup>, 2 kg

**Angle Grinder - 9558HN** 325

125mm Rs. 8,710



840W, 11000 rpm, 1.7-3.0kg

**Angle Grinder - 9565PCV**

125 **new**



12,000 min<sup>-1</sup>, 1,400W, 2.4 - 3.5 kg

**Angle Grinder - 9553NB** 325

100mm Rs. 8,330



710W, 11000 rpm, 1.8kg

**Angle Grinder - 9553B** 325

100mm Rs. 8,280



710W, 11000 rpm, 1.9kg

**Angle Grinder - GA4032** 459

100mm Rs. 7,540



720W, 9000 rpm, 1.96 kg

**Angle Grinder - GA9060** 218

230mm Rs. 14,500



2200W, 6600 rpm, 5.5kg

**Angle Grinder - GA7070** 224

180mm Rs. 33,300



**AFT**

2,800W, 3,500 rpm, 6.6 kg

**Angle Grinder - GA9070** 224

230mm Rs. 35,640



**AFT**

2,800W, 6,600 rpm, 8.5 kg

**Angle Grinder - GA7080**

180mm Rs. 28,560



2,700W, 8,500 rpm, 6.2 kg

**Angle Grinder - GA9080**

230mm Rs. 29,700



2,700W, 6,600 rpm, 6.4 kg

**Angle Grinder - GA7081**

180mm Rs. 26,200



2,700W, 8,500 rpm, 6.0 kg

**Angle Grinder - GA9081**

230mm Rs. 27,370



2,700W, 6,600 rpm, 6.1 kg

**Angle Grinder - GA7082**

180mm Rs. 23,770



2,700W, 8,500 rpm, 6.0 kg

**Angle Grinder - GA9082**

230mm Rs. 25,050



2,700W, 6,600 rpm, 6.1 kg

**Angle Grinder - GA7090**

180mm Rs. 14,200



2,200 W, 8,500 min<sup>-1</sup>, 5.1 kg

**Angle Grinder - GA9090**

230mm Rs. 15,150



2,200 W, 6,600 min<sup>-1</sup>, 5.3 kg

**Angle Grinder - GA9040S** 204

230mm Rs. 22,390



2600W, 6600 rpm, 8.94 kg

**Angle Grinder - GA7061R** 218

180mm Rs. 23,440



Anti-restart function 

2200W, 8500 rpm, 6.08 kg

**Angle Grinder - GA9061R** 218

230mm Rs. 25,890



Anti-restart function 

2200W, 6600 rpm, 8.04 kg

**Angle Grinder - GA7061** 218

180mm Rs. 20,690





2200W, 8500 rpm, 6.04 kg

**Angle Grinder - GA9061** 218

230mm Rs. 23,000





2200W, 6600 rpm, 7.99kg

**Angle Grinder - GA7060** 218

180mm Rs. 19,540



2200W, 8500 rpm, 5.89kg

**Angle Grinder - GA7020** 204

180mm GA7020 - Rs. 16,970



2200W, 8500 rpm, 6.06kg

**Angle Grinder - GA9020** 204

230mm Rs. 17,720



2200W, 6600 rpm, 8.05kg

**Angle Grinder - GA7050** 204

180mm Rs. 15,610



2000W, 8500 rpm, 5 kg

**Angle Sander - SA7000C** 204

180mm Rs. 26,200



1600W, 4000 rpm, 3.6kg

**Brushless Cordless Polisher - PV001G**

180mm

PV001GM101 - Rs. 79,570  
PV001GZ - Rs. 46,680



**XGT BL XPT**

40V max 165 mm, 2,200 rpm 3.8kg

**Polisher - 9237C** 303

180mm Rs. 29,490



1200W, 3200 rpm, 3.4kg

**Brushless Cordless Sander Polisher - DPV300**

127mm

DPV300Z - Rs. 28,320



**LXI BL XPT**

18V 2.5 m/s<sup>2</sup> or less 0 - 2,800 RPM 1.6 kg

**Brushless Cordless Sander Polisher - PV301D**

127mm

PV301DSYE - Rs. 42,670  
PV301DZ - Rs. 32,790



**LXI BL XPT**

12V max Polishing: 0 - 2,800 Sanding: 0 - 9,500RPM, 1.2 kg

**Random Orbit Polisher - PO5000C** 318

125mm Rs. 39,270



900W, 6800 opm, 780 rpm, 3.0kg

**Stone Polisher - PW5001C** 318

125mm Rs. 42,850



100 - 125 mm (4 - 5"), 2.6 kg

Grinding/Sanding/  
Polishing

**Cordless Die Grinder - DGD801** 430

8 mm DGD801Z - Rs. 17,750



LXT

18V C Size 3 / 6 / 8 mm, SP, 26,000 min<sup>-1</sup> 2 kg

**Cordless Die Grinder - DGD800** 430

8 mm DGD800Z - Rs. 17,500



LXT

18V C Size 3 / 6 / 8 mm, SP, 26,000 min<sup>-1</sup> 2.2 kg

**Die Grinder - GD0801C** 318

8mm Rs. 34,380



750W, 29000 rpm, 1.97kg

**Die Grinder - GD0600** 325

6mm Rs. 11,490



new

400W, 25,000 rpm, 1.87 kg

**Die Grinder - GD0602**

6 mm GD0602 - Rs. 7,510



400 W, 25,000 RPM, 1.41 - 1.57 kg

**Die Grinder - GD0603** 64

6mm Rs. 9,670



240W, 28000 rpm, 0.98kg

**Die Grinder - GD0601** 325

6mm GD0601 - Rs. 11,150



400W, 25000 rpm, 1.84kg

**Straight Grinder - GS6000** 204

150mm Rs. 34,380



750W, 5600 rpm, 5.4kg

**Bench Grinder - GB801**

205mm Rs. 30,570



550W, 2850(50Hz)/3450(60Hz) rpm,

**Straight Grinder - GS5000** 204

125mm Rs. 31,730



750W, 5600 rpm, 5.2kg

**Bench Grinder - GB602**

150mm Rs. 18,780



250W, 2850(50Hz)/3450(60Hz) rpm, 9.08kg

**Random Orbit Sander - B06030** 419

150mm Rs. 25,050



310W, 4000-10000 opm, 2.4kg

**Battery Powered Random Orbit Sander - B0001CG**

125 mm B0001CGZ - Rs. 35,320



Orbit diameter: 5 mm

XGT BL AWS XPT

40V max High: 10,000 / Low: 6,000 (OPM), 1.0 kg

**Battery Powered Random Orbit Sander - B0002CG**

150 mm B0002CGZ - Rs. 36,490



Orbit diameter: 5 mm

XGT BL AWS XPT

40V max High: 10,000 / Low: 6,000 (OPM), 1.0 kg

**Battery Powered Random Orbit Sander - B0003CG**

125 mm B0003CGZ - Rs. 35,320



Orbit diameter: 3 mm

XGT BL AWS XPT

40V max High: 10,000 / Low: 6,000 (OPM), 1.0 kg

**Battery Powered Random Orbit Sander - B0004CG**

150 mm B0004CGZ - Rs. 36,490



Orbit diameter: 3 mm

XGT BL AWS XPT

40V max High: 10,000 / Low: 6,000 (OPM), 1.0 kg

**Battery Powered Orbital Sander - B0005CG**

130 mm B0005CGZ - Rs. 36,490



Orbit diameter: 3 mm

XGT BL AWS XPT

40V max High: 10,000 / Low: 6,000 (OPM), 1.0 kg

**Battery Powered Orbital Sander - B0006CG**

150 mm B0006CGZ - Rs. 36,490



Orbit diameter: 3 mm

XGT BL AWS XPT

40V max High: 10,000 / Low: 6,000 (OPM), 1.0 kg

**Random Orbit Sander - B05031** 419

125mm Rs. 16,350



300W, 4000-12000 opm, 1.3kg

**Cordless Finishing Sander - DB0480**

DB0480RTJ - Rs. 57,070  
DB0480Z - Rs. 22,610



LXT

18V 112 x 102 mm, 14,000 Opm, 1.7kg

**Cordless Finishing Sander - DB0482**

DB0482RTJ - Rs. 55,910  
DB0482Z - Rs. 21,430



LXT

18V 112 x 102 mm, 14,000 Opm, 1.8kg

## Brushless Cordless Finishing Sander - DB0380



DB0380RTJ - Rs. 53,480  
DB0380Z - Rs. 18,000

**LXI BL XPT**

18V 93 x 185 mm, 12,000 Opm, 2.2kg

## Brushless Cordless Finishing Sander - DB0381



DB0381Z - Rs. 21,430

**LXI BL AWS XPT**

18V 93 x 185 mm, 12,000 Opm, 2.2kg

## Finishing Sander - B04556



419  
Rs. 10,280

200W, 14000 opm, 1.1kg

## Finishing Sander - B03710



64  
Rs. 9,240

190W, 11000 opm, 1.6kg

## Brushless Cordless Belt Sander - BS001G



533 mm  
BS001GM201 - Rs. 1,16,650  
BS001GZ - Rs. 48,320

**XGT BL AWS XPT**

40V max 95 dB(A), 76 mm (3"), 480 mm, 5.1 kg



## Brushless Cordless Drywall Sander - DSL801



225 mm  
DSL801ZU - Rs. 82,010  
DSL801Z - Rs. 76,500

**LXI BL AWS XPT**

18V 2.5 m/s<sup>2</sup> or less 1,800 RPM 5.8 kg



## Brushless Cordless Belt Sander - DBS180



9mm x  
DBS180Z - Rs. 35,320

**LXI BL**

18V 2.5 m/s<sup>2</sup> or less, 533 mm (21"), 2.1 kg

## Belt Sander - 9032



411  
Rs. 27,060

500W, 300-1700m/min, 1.6kg

## Belt Sander - 9031



411  
Rs. 31,190

550W, 200-1000m/min, 2.1kg

## Wheel Sander - 9741



100  
Rs. 26,500

860W, 3500 rpm, 4.2kg

# Cutting

## Brushless Cordless Cutter - DCC501



125mm  
DCC501TX2 - Rs. 68,980  
DCC501ZX2 - Rs. 32,160

**LXI BL ADT AWS XPT**

18V 20 mm (13/16"), 8,800 rpm, 3.0kg

## Dustless Cutter - 4100KB



303  
Rs. 13,250

1400W, 12200 rpm, 3.0 kg

## Brushless Cordless Metal Cutter - CS002G



185mm  
CS002GZ - Rs. 68,980

**XGT BL ADT**

40V max 0°: 67 mm (2-5/8"), 3,500 rpm, 4.9kg

## Metal Cutter - 4131



303  
Rs. 37,160

1100W, 3500 rpm, 4.8 kg

## Metal Cutting Saw - LC1230



203  
Rs. 56,990

1750W, 1300 rpm, 19.3 kg

## Angle Cutter - 4114S



204  
Rs. 68,960

**SJS**

2400W, 3500 rpm, 10.8 kg

## Wall Chaser - SG1251J



318  
Rs. 73,530

**SJS**

1400W, 10000 rpm, 4.3 kg

## Brushless Cordless Power Cutter - CE001G



CE001GZ - Rs. 1,29,200

**XGT X2 80Vmax**

**XGT BL AFT WG XPT**

40V max x2 127 mm (5"), 5,300 rpm, 12.9 kg

**Brushless Cordless Power Cutter - CE002G**

355mm 14" CE002GZ - Rs. 1,44,200



XGT X2 80Vmax

XGT BL AFT AWS

40V max x2 127 mm (5"), 4,200 rpm, 15.1 kg

**Brushless Cordless Power Cutter - CE003G**

230mm (9") CE003GZ02 - Rs. 75,750



XGT BL AFT XPT

40V max 6,600 min<sup>-1</sup>, 105 dB(A), 7.4 kg

**Brushless Cordless Power Cutter - CE004G**

305mm (12") CE004GZ - Rs. 81,450



XGT BL AFT XPT

40V max 5,000 min<sup>-1</sup>, 110 dB(A), 7.7 kg

**Brushless Cordless Power Cutter - DCE090**

230mm 9" DCE090T2X1 - Rs. 1,20,210  
DCE090ZX1 - Rs. 79,400



18V + 18V → 36V

LXT BL AFT XPT

18V x2 88 mm, 6,600 rpm, 6.3 kg

**Brushless Cordless Portable Cut-Off - DLW140**

355mm DLW140PT2 - Rs. 93,040  
DLW140Z - Rs. 52,990



18V + 18V → 36V

LXT BL

18V x2 25.4mm, 3800 rpm, 17.8kg

**Cordless Steel Rod Cutter - DSC191**

DSC191Z - Rs. 3,26,650



LXT

18V Dia.: 3 - 20 mm, 11.2kg

**Portable Cut-off - LW1400** 203

355mm Rs. 29,170



Rectangular stock (H x W):  
102x194mm (4"x7-5/8")

2200W, 3800 rpm, 18.7 kg

**Portable Cut-off - LW1401** 203

355mm Rs. 26,320



Rectangular stock (H x W):  
70x233mm (2-3/4"x9-1/8")

2200W, 3800 rpm, 18.3 kg

**Brushless Cordless Steel Rod Cutter - DSC251**

DSC251ZK - Rs. 1,18,320



LXT BL ADT

18V Dia.: 25 mm, 4.0 kg

**Brushless Cordless Threaded Rod Cutter - DSC102**

110mm DSC102Z - Rs. 85,720



LXT BL

18V 20 mm, 2200rpm, 3.2 kg

**Brushless Cordless Threaded Rod Cutter - SC103D**

20mm SC103DZ - Rs. 79,680



CXT BL

12V max Ms/Ss: M10/W3/8, 2.8 kg

**Brushless Cordless Compact Cut Off - DMC300**

76mm DMC300RFJ - Rs. 47,600  
DMC300Z - Rs. 21,100



LXT BL AFT XPT

18V 76 mm (3"), 20,000 min<sup>-1</sup> rpm 1.7 kg

**Cordless Multi Cutter - CP100D**

CP100DWA - Rs. 16,430  
CP100DZ - Rs. 7,440



CXT

12V max 6mm, 300 rpm, 0.88kg

**Brushless Cordless Metal Shear - DJS200**

2.0mm DJS200Z - Rs. 64,990



LXT BL XPT

18V 0 - 3,000 spm, 2.5 kg

**Cordless Metal Shear - DJS130** 440

1.3mm DJS130ZJ - Rs. 45,320



LXT

18V 2,800 rpm, 2.6 kg

**Cordless Hole Puncher - DPP200**

20mm DPP200ZK - Rs. 3,15,180



LXT

18V 40 mm (1-9/16") 10.5 kg

**Brushless Cordless Hole Puncher - PP001G**

20mm PP001GZK - Rs. 3,99,990



new

XGT BL

40V max 77 dB(A), 1.5 m/s<sup>2</sup>, 2.5 m/s<sup>2</sup>, 12.8 kg

**Brushless Cordless Portable Band Saw - PB002G**

PB002GM201 - Rs. 1,23,070  
PB002GZ - Rs. 68,980



XGT BL XPT

40V max 0 - 3.2 m/min, 3 dB(A), 7.1kg

**Brushless Cordless Portable Band Saw - DPB183**

66mm DPB183RTE - Rs. 74,370



LXT BL

18V 0 - 3.2 m/s, 3.9 kg

**Portable Band Saw - 2107FK** 303

120x120mm Rs. 50,920



710W, 60m-105min, 6.3 kg

**Metal Shear - JS1602** 459

(16Ga) Rs.37,140



380W, 4000 spm, 1.6 kg

**Cordless Nibbler - DJN161** 430

1.6mm DJN161Z - Rs. 40,490



**18V** 45 mm (1-3/4"), 50 mm (2"), 1,900 spm, 2.3 kg

LXT

**Cordless Metal Shear - DJ5131**

1.3mm DJ5131Z



**new**

LXT BL XPT

**18V** 18 Ga, 3,000 min<sup>-1</sup>, 2.0-2.3 kg

**Cordless Straight Shear - DJ5161**

1.6mm DJ5161Z - Rs. 38,430



**18V** 4300 SPM, 2.2 kg

**Metal Shear - JS3201** 303

3.2mm Rs. 40,330



710W, 1600 spm, 3.4 kg

**Straight Metal Shear - JS1601** 459

(16Ga) Rs. 33,940



380W, 4,500 min<sup>-1</sup>, 1.4 kg

**Aluminum Groove Cutter - CA5000X** 303

118mm CA5000X - Rs. 86,650



1,300W, 118 mm (4-5/8"), 4.7 kg

**Nibbler - JN3201** 303

3.2mm JN3201 - Rs. 49,880



710W, 1300 spm, 3.4 kg

**Nibbler - JN1601** 411

1.6mm JN1601 - Rs. 32,890



550W, 2200 spm, 1.6 kg

**Cordless Cable Cutter - DTC100**

50mm DTC100ZK - Rs. 2,54,840



**18V** 600V-CV: 500mm<sup>2</sup>, 6600V-CV: 500mm<sup>2</sup>, 2.9 kg

LXT

**Cordless Cable Cutter - DTC101**

50mm DTC101ZK - Rs. 2,94,170



**18V** 600V-CV: 500mm<sup>2</sup>, 6600V-CV: 500mm<sup>2</sup>, 3.6 kg

LXT

**Brushless Cordless Cable Cutter - DTC102**

65mm DTC102ZK



**new**

LXT

**18V** 116 x 228 x 400 mm, 65 mm, 3.5 kg

**Cordless Cable Cutter - DTC103**

54mm DTC103ZK



**new**

LXT

**18V** AI 550mm<sup>2</sup> / ST 70mm<sup>2</sup>, 5.5 kg

**Cordless Cable Cutter - DTC104**

105mm DTC104ZK



**new**

LXT

**18V** 1,300 mm<sup>2</sup>, 120 kN, 10.2 - 10.5 kg

**Cordless Crimper - DTC301**

31mm DTC301ZK



**new**

LXT

**18V** 120 kN, 31 mm, 6.8 - 7.1 kg

**Cordless Crimper - DTC302**

42mm DTC302ZK



**new**

LXT

**18V** 120 kN, 1.5 m/s<sup>2</sup>, 7.5 - 7.8 kg

**Sawing**

**Brushless Cordless Slide Compound Miter Saw - LS002G**

216mm LS002GZ - Rs. 1,04,990



XGT BL AWS DXT

**40V max** 50mm, 48° L/R 4,800 rpm, 17.0 kg

**Brushless Cordless Slide Compound Miter Saw - LS003G**

305mm LS003GZ - Rs. 1,42,590



XGT BL AWS DXT

**40V max** 3,600 RPM 31.1 kg

**Brushless Cordless Slide Compound Miter Saw - LS004G**

260mm LS004GZ - Rs. 1,18,820



XGT BL AWS DXT

**40V max** 3,600 RPM 27.2 kg

**Slide Compound Miter Saw - LS1219L** 153

305mm Rs. 1,18,840



DXT

1,800W, 3,200 rpm, 29.5kg

**Slide Compound Miter Saw - LS0816F**

216mm Rs. 41,100



1,200W, 5,000 min<sup>-1</sup>, 13.9 kg

Cutting

Sawing

## Slide Compound Miter Saw - LS1019L 153

260mm Rs. 97,410



**DXT**

1,510W, 3200 rpm, 26.3kg

## Slide Compound Miter Saw - LS1110F

255-260 Rs. 64,990



1,450W, 4,500 rpm, 16.4 kg

## Compound Miter Saw - LS1221 153

305mm Rs. 84,040



1650W, 4000 rpm, 16.8kg

## Table Top Miter Saw - LH1201FL

305mm LH1201FL - Rs. 98,320



**LXT BL**

3,800 RPM, 3,800 min<sup>-1</sup>, 20.9 kg

## Compound Miter Saw - LS1045 153

260mm Rs. 54,960



Cast Iron base

1650W, 4600 rpm, 19.1kg

## Compound Miter Saw - LS1040 153

260mm LS1040X2 - Rs. 41,760  
LS1040 - Rs. 41,820



1650W, 4600 rpm, 12.4kg

## Table Saw - MLT100 JM23000123

260mm Rs. 77,360



1500W, 4300 rpm, 34.9kg

## Table Saw - 2712

315mm Rs. 64,260



90°: 85 mm, 54kg

## Brushless Cordless Circular Saw - HS013G

415mm HS013GT101 - Rs. 1,41,150  
HS013GZ - Rs. 96,150



**new**

**XGT BL AFT AWS XPT**

40V max at 0° mm, at 45°, 2,100 rpm, 12.0 kg

## Brushless Cordless Circular Saw - HS012G

165mm HS012GD201 - Rs. 1,06,090  
HS012GZ - Rs. 60,490



**XGT BL AWS XPT**

40V max 0°: 57 mm, 45°: 41 mm, 5,200 rpm, 4.4 kg

## Brushless Cordless Circular Saw - HS011G

270mm HS011GT201 - Rs. 1,37,920  
HS011GZ - Rs. 65,360



**XGT BL AWS XPT**

40V max 45°: 68 - 71 mm, 3,500 rpm, 5.7 kg

## Brushless Cordless Circular Saw - HS009G

235mm HS009GT201 - Rs. 1,29,550  
HS009GZ - Rs. 57,070



**XGT BL AWS XPT**

40V max 60°: 44 mm (1-3/4"), 4,000 rpm, 5.7 kg

## Brushless Cordless Circular Saw - HS003G

190/185mm HS003GM201 - Rs. 1,04,600  
HS003GZ - Rs. 44,040



**XGT BL ADT AWS XPT**

40V max 15.88 / 20 / 30 mm, 6,000 rpm, 4.4 kg

## Brushless Cordless Rear Handle Saw - RS002G

260mm RS002GT101 - Rs. 95,050  
RS002GZ - Rs. 50,400



**XGT BL AWS XPT**

40V max 4,000 RPM 6.3 kg

## Brushless Cordless Rear Handle Saw - RS001G

185mm RS001GM101 - Rs. 76,070  
RS001GZ - Rs. 37,000



**XGT BL ADT XPT**

40V max 6,400 RPM 5.6 kg

## Brushless Cordless Circular Saw - DHS900

235mm DHS900PT2 - Rs. 1,01,650  
DHS900Z - Rs. 61,220



**18V x2**

**LXT BL AWS ADT XPT**

4500 rpm, 5.3 - 6.0 kg

## Circular Saw - N5900B 153

235mm Rs. 20,380



2000W, 4100 rpm, 6.8kg

## Circular Saw - HS7010 303

185/190mm HS7010 - Rs. 18,260



1600W, 5500 rpm, 4.0kg

## Circular Saw - HS7600 303

185mm Rs. 16,120



1200W, 5200 rpm, 3.8kg

## Circular Saw - HS0600 153

260/270mm Rs. 38,400



2000W, 4300 rpm, 6.9kg

## Circular Saw - 5402NA 203

415mm Rs. 96,230



Low voltage

1650W, 2200 rpm, 12.5kg

**Brushless Cordless Plunge Cut Saw - SP001G**

165mm  
SP001GZ - Rs. 59,420



40V max 20 mm (13/16") 4,900 rpm, 5.0 kg

XGT BL ANS XPT

**Plunge Cut Circular Saw - SP6000** 303

165mm  
Rs. 54,980



1300W, 2000-5800 rpm, 4.1 kg

**Band Saw - LB1200F** 303

305mm (12")  
Rs. 1,03,880



900W, 82kg

**Brushless Cordless Jig Saw - JV002G**

26mm  
JV002GZ - Rs. 43,870



40V max 6.1 m/s<sup>2</sup>, 0-3,500 spm, 3.0 kg

XGT BL SOFT XPT

**Brushless Cordless Jig Saw - JV001G**

26mm  
JV001GD201 - Rs. 87,330  
JV001GZ - Rs. 41,700



40V max 2.5 m/s<sup>2</sup>, 800-3,500 spm, 2.9 kg

XGT BL SOFT XPT

**Brushless Cordless Jig Saw - DJV181**

26mm  
DJV181Z - Rs. 40,430



18V W - 135 mm, 10mm / 3,500 spm, 2.6 kg

LXI BL SOFT

**Brushless Cordless Jig Saw - DJV184**

23mm  
DJV184RTJ - Rs. 59,420  
DJV184Z - Rs. 25,050



18V 3000 spm, 2.5 kg

LXI BL SOFT XPT

**Brushless Cordless Jig Saw - DJV185**

23mm  
DJV185RTJ - Rs. 66,850  
DJV185Z - Rs. 36,080



18V 800-3,000 spm, 2.3 kg

LXI BL SOFT XPT

**Jig Saw - 4350CT** 419

Rs. 26,630



720W, 800-2800 rpm, 2.7kg

**Jig Saw - JV0600K** 64

Rs. 17,410



650W, 500-3100 rpm, 2.4kg

**Jig Saw - 4327** 64

Rs. 9,460



450W, 500-3100 rpm, 1.9kg

**Brushless Cordless Recipro Saw - JR002G**

32mm  
JR002GD201 - Rs. 1,02,280  
JR002GZ - Rs. 45,190



40V max 130/255 mm, 0-3,000 rpm, 5.2 kg

XGT BL AVT XPT

**Brushless Cordless Recipro Saw - JR001G**

32mm  
JR001GM201 - Rs. 96,340  
JR001GZ - Rs. 35,640



40V max Pipe/Wd: 130/255mm, 3,000 spm, 4.5 kg

XGT BL XPT

**Brushless Cordless Recipro Saw - DJR189**

22mm  
DJR189RTJ - Rs. 71,240  
DJR189Z - Rs. 36,890



18V Pipe/Wd: 255/130mm 3,100 spm, 2.5 kg

LXI BL XPT

**Cordless Recipro Saw - DJR186**

32mm  
DJR186RFE - Rs. 39,250  
DJR186Z - Rs. 12,000



18V Pipe/Wd: 130/255mm, 2800 spm, 3.8kg

LXI XPT

**Brushless Cordless Recipro Saw - DJR188**

20mm  
DJR188RFJ - Rs. 49,010



18V Pipe/Wd: 130/255mm, 3000 spm, 2.9kg

LXI BL XPT

**Cordless Recipro Saw - JR103D**

13mm  
JR103DWYE - Rs. 25,890  
JR103DZ - Rs. 9,000



12V max W/S: 50/50mm, 3300 spm, 1.5kg

CXI

**Recipro Saw - JR3070CT** 303

Rs. 27,340



1510W, 2800 spm, 4.6 kg

AVT

**Recipro Saw - JR3051TK** 303

30mm  
Rs. 17,820



1,200W, 0-3,000 spm, 3.3 kg

**Cordless Drywall Saw - SD100D**

6mm  
SD100DWJ - Rs. 37,240



12V max Drywall/Wd: 30/15mm, 6000 spm, 1.6kg

CXI

**Scroll Saw - SJ401**

50mm  
Rs. 35,870



50W, 400-1,600 spm, 14kg

## Brushless Cordless Multi Tool - TM001G

TM001GD201 - Rs. 86,320  
TM001GZ - Rs. 31,490



XGT BL AVT XPT

40V max 3.6°, 10,000 - 20,000 min<sup>-1</sup>, 3.3 kg

## Cordless Multi Tool - DTM51

DTM51RTE - Rs. 39,000  
DTM51RFE - Rs. 37,100  
DTM51Z - Rs. 16,320



LXI

18V 3.2°, 20,000 opm, 3.0 m/s<sup>2</sup>, 2.4 kg

## Multi Tool - TM3000CX1

459  
Rs. 21,390



320W, 6000-20000 spm, 1.5kg

## Milling / Planing

## Brushless Cordless Planer - KP001G

82 mm  
KP001GM201 - Rs. 1,02,280  
KP001GZ - Rs. 41,590



XGT BL AWS

40V max 25 mm (1"), 15,500 rpm, 5.4 kg

## Brushless Cordless Planer - DKP181

82 mm  
DKP181RTJ - Rs. 66,210  
DKP181Z - Rs. 30,680



LXI BL AWS ADT

18V 3 mm (1/8") 12,000 rpm, 3.6 kg

## Plate Joiner - PJ7000

459  
Rs. 27,340



710W, 11000 rpm, 2.8kg

## Power Planer - 1911B

106  
Rs. 36,280



840W, 16000 rpm, 4.1kg

## Planer - 2012NB

153  
Rs. 89,330



1650W, 8500 rpm, 27.6kg

## Concrete Planer - PC5000C

253  
Rs. 56,880



1400W, 10000 rpm, 4.0kg

## Brushless Cordless Cut-Out Tool - DC0181

DC0181Z - Rs. 23,650



LXI BL AWS ADT

18V 3, 6 mm, 32,000 rpm, 1.7 kg

## Concrete Planer - PC5010C

318  
Rs. 44,090



1400W, 9000 rpm, 3.6kg

## Brushless Cordless Trimmer - RT001G

6.8 mm  
RT001GM207 - Rs. 1,04,600  
RT001GZ14 - Rs. 44,040



XGT BL AWS XPT

40V max 1.5 m/s<sup>2</sup>, 31,000 rpm 2.5kg

## Cordless Trimmer - DRT52

6 mm  
DRT52SF - Rs. 36,550  
DRT52Z - Rs. 20,820



LXI XPT

18V 30,000 min<sup>-1</sup>, 89 dB(A) 1.6 kg

## Brushless Cordless Trimmer - DRT50

6-8mm  
DRT50Z - Rs. 25,340



LXI BL

18V 30,000 rpm, 2.1 kg

## Trimmer - RT0702C

6.8mm  
Rs. 17,820



710W, 34,000 rpm, 2.8 kg

## Trimmer - 3709

411  
Rs. 10,280



530W, 30000 rpm, 1.5kg

## Brushless Cordless Router - RP001G

RP001GM201 - Rs. 1,03,990  
RP001GZ - Rs. 43,320



XGT BL AWS XPT

40V max 8,000-25,000 min<sup>-1</sup>, 6.3 m/s<sup>2</sup>, 5.2 kg

## Router - RP2303FC

12mm  
RP2303FC05 - Rs. 54,590  
RP2303FC - Rs. 53,050



2,100W, 23,000 rpm, 6.2 kg

## Router (Plunge type) - RP2301FC

203  
Rs. 53,050



2100W, 9000-22000 rpm, 6.1kg

## Router (Plunge type) - RP1800

12mm  
RP1800X05 - Rs. 44,170  
RP1800 - Rs. 40,540



1850W, 22000 rpm, 6.0kg

## Fastening / Fixing

### Chain Mortiser - 7104L

153

130 mm



7104L - Rs. 1,50,000

Capacity, 130 mm, 155 mm 18.2 kg

### Brushless Cordless Pin Nailer - PT001G

35 mm



PT001GD101 - Rs. 88,070  
PT001GZ - Rs. 58,350

XGT BL XPT

40V max

120, w/ BL4025: 6,000 shots, 3.0kg

### Cordless Pin Nailer - DPT353

15 to 35 mm



DPT353Z - Rs. 38,750

LXT

18V

Dia.: 0.6 mm, Gauge: 23 Ga 2.3 kg

### Cordless Pin Nailer - PT354D

23 Ga



PT354DZ - Rs. 30,000

XGT

12V max

0.6x35mm, 120 nos, 2.0kg

### Brushless Cordless Rivet Gun - DRV250

20 kN



DRV250RFE - Rs. 1,39,990  
DRV250Z - Rs. 1,20,210

LXT BL XPT

18V

30 mm, 2.4 - 6.4 mm, 2.4 kg

### Brushless Cordless Rivet Gun - DRV150

10 kN



DRV150RFE - Rs. 1,46,520  
DRV150Z - Rs. 1,20,210

LXT BL XPT

18V

25 mm, 2.4 - 4.8 mm, 1.9 - 2.2 kg

### Brushless Cordless Rebar Tying Tool - DTR181

22mm



DTR181RTE - Rs. 1,64,030  
DTR181Z - Rs. 1,27,310

LXT BL XPT

18V

1.5 m/s<sup>2</sup>, 82 dB(A), 2.7 kg

### Brushless Cordless Rebar Tying Tool - DTR180

16 kN



DTR180Z - Rs. 1,20,210

LXT BL XPT

18V

∅0.8 mm, D10 x D10 - (D13 x 2) x (D13 x 2), 2.6kg

### Brushless Cordless Brad Nailer - FN001G

40 mm



FN001GD101 - Rs. 89,120  
FN001GZ - Rs. 59,420

XGT BL XPT

40V max

Length: 40 mm Gauge: 18 Ga 3.2 kg

### Pneumatic Brad Nailer - AF505

50 mm (2')



AF505N - Rs. 9,450

PNEUMATICS

Capacity, 15 - 50 mm, 18 Ga, 1.4 kg

### Pneumatic Pallet Coil Nailer - AF506

18 GA



Rs. 14,550

PNEUMATICS

100pcs, 0.49 - 0.83 MPa, 1.3kg

### Pneumatic Coil Nailer - AN454

45 mm



Rs. 33,170

PNEUMATICS

MC120, 0.49 - 0.83 MPa, 2.4 kg

### Pneumatic Coil Nailer - AN961

100mm



Rs. 98,150

PNEUMATICS

MC300, 0.49 - 0.83 MPa, 5.3 kg

### Pneumatic Coil Nailer - AN613

65 mm

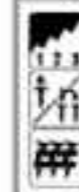

Rs. 44,040

PNEUMATICS

Capacity, 38 - 65 mm, 2.3 - 2.5 mm Ga, 0.9 kg

### Pneumatic Pin Nailer - AF353

35 mm



Rs. 20,990

PNEUMATICS

Capacity, 15 - 35 mm, 23 Ga, 0.9 kg

### Pneumatic Framing Nailer - AN924

90 mm

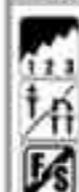

Rs. 48,320

PNEUMATICS

MC73, 0.49 - 0.83 MPa, 3.8 kg

### Pneumatic Framing Nailer - AN943

90 mm



new

PNEUMATICS

50 - 90 mm, 0.44 - 0.83 MPa, 4 kg

### Pneumatic Finish Nailer - AF635

64 mm (2-1/2")



Rs. 28,650

PNEUMATICS

Capacity, 32 - 64 mm, 15 Ga, 1.8 kg

### Pneumatic Finish Nailer - AF601

25 - 64 mm



Rs. 26,650

PNEUMATICS

Capacity, 25 - 64 mm, 16 Ga, 1.7 kg



**Cordless Stapler - DST112**  
 10mm DST112Z - Rs. 28,600  
  
**LXI XPT**  
 18V W: 10 mm, L: 7 - 10 mm, 1.8 kg

**Cordless Stapler - DST221**  
 10mm DST221Z - Rs. 28,250  
  
**LXI**  
 18V W: 10 mm, L: 10,13,16,19,22mm, 2.4 kg

**Medium Crown Stapler - AT1150A**  
 11mm (7/16") AT1150A - Rs. 48,320  
  
**PNEUMATICS**  
 Capacity, 25 - 50 mm, 16 Ga, 2.3 kg

**Wide Crown Stapler - AT2550A**  
 25mm (1") AT2550A - Rs. 51,650  
  
**PNEUMATICS**  
 Capacity, 25 - 50 mm, 16 Ga, 2.3 kg

**Narrow Crown Stapler - AT638A**  
 38mm (1-1/2") AT638A - Rs. 19,990  
  
**PNEUMATICS**  
 Capacity, 13 - 38 mm, 18 Ga, 1.2 kg



## Dust management

**Brushless Cordless Vacuum Cleaner - VC006GM**  
 VC006GMZ03 - Rs. 1,59,140  
  
**XGT X2 80Vmax**  
 Wet & Dry  
 40V max x2 Dust/Water: 40 / 30 L 18 kPa, 20.8 kg

**Brushless Cordless Vacuum Cleaner - VC005GL**  
 VC005GLZ - Rs. 71,300  
  
**XGT BL XPT**  
 Dry only  
 40V max Dust: 8 L, 23 kPa, 265 W, 9.5 kg

**Brushless Cordless Vacuum Cleaner - VC003GL**  
 VC003GLZ - Rs. 68,980  
  
**XGT BL XPT**  
 Wet & Dry  
 40V max D/W: 15 / 12 L, 23 kPa, 310 W, 10.2 kg

**Brushless Cordless Vacuum Cleaner - VC002GL**  
 VC002GLZ - Rs. 77,230  
  
 Dry only  
**XGT BL AWS XPT**  
 40V max Dust: 8 L, 23 kPa, 205 W, 10.2 kg

**Brushless Cordless Vacuum Cleaner - VC001GL**  
 VC001GLZ - Rs. 65,360  
  
**XGT BL XPT**  
 Wet & Dry  
 40V max D/W: 8 / 6 L, 23 kPa, 310 W, 10.0 kg

**Brushless Cordless Vacuum Cleaner - DVC155L**  
 DVC155LZX3 - Rs. 51,470  
  
**XGT BL XPT**  
 Wet & Dry  
 18V x2 Dust: 15 / 12 L, 11 kPa, 7.9 kg

**Brushless Cordless Vacuum Cleaner - DVC865L**  
 DVC865LZX3 - Rs. 49,010  
  
**XGT BL XPT**  
 Wet & Dry  
 18V x2 Dust: 8 / 6 L, 11 kPa, 7.7 kg

**Brushless Cordless Vacuum Cleaner - DVC862L**  
 DVC862LRT2 - Rs. 83,400  
 DVC862LZ - Rs. 40,000  
  
**XGT BL XPT HEPA Filter**  
 Wet & Dry  
 18V x2 Dust: 8 L, 2.1 m³/min, 9.8 kPa, 7.6kg

**Vacuum Cleaner - VC4210L**  
 34 L VC4210L - Rs. 1,16,650  
  
 Wet & Dry  
 25.0 kPa, 1,200W, 4.5 m³/min, 16 kg

**Vacuum Cleaner - VC3012L**  
 24 L VC3012L - Rs. 78,320  
  
 Wet & Dry  
 25.0 kPa, 1,500W, 3.7 m³/min, 11 kg

**Vacuum Cleaner - VC2512L**  
 21 L VC2512L - Rs. 39,320  
  
 Wet & Dry  
 21.0 kPa, 1,000W, 3.6 m³/min, 7 kg

**Electric Vacuum Cleaner - VC2510LX1**  
 25L VC2510LX1 - Rs. 54,960  
  
 Wet & Dry  
 22 kPa, 1050W, 2.0m³ / min, 10.5kg

**Electric Vacuum Cleaner - VC3210LX1**  
 32L VC3210LX1 - Rs. 63,250  
  
 Wet & Dry  
 22 kPa, 1050W, 2.0m³ / min, 14.5kg

**Electric Vacuum Cleaner - VC2000L**  
 20L VC2000L - Rs. 27,490  
  
 Wet & Dry  
 21 kPa, 1000W, 2.0m³ / min, 7.5kg

**Brushless Cordless Backpack Vacuum Cleaner - VC011G**  
 VC011GZ - Rs. 64,950



**40V max** Dust: 6.0L, 20 kPa, 9.5 kg

XGT BL HEPA MOTOR filter

**Brushless Cordless Backpack Vacuum Cleaner - VC008G**  
 VC008GZ - Rs. 51,120



**40V max** Dust: 1.5L, 18 kPa, 10.2 kg

XGT BL MOTOR

**Brushless Cordless Backpack Vacuum Cleaner - DVC660**  
 DVC660Z - Rs. 44,650



**18V x2** Dust: 6 L, 5.5 L, 11 Kpa, 6.7 kg

XGT BL HEPA MOTOR filter

**Brushless Cordless Backpack Vacuum Cleaner - DVC665**  
 DVC665Z - Rs. 44,140



**18V x2** Dust: 6 L, 5.5 L, 11 Kpa, 6.7kg

XGT BL HEPA AWS MOTOR filter

**Brushless Cordless Backpack Vacuum Cleaner - DVC261**  
 DVC261Z - Rs. 36,810



**18V x2** Dust: 2.0L, 2.3 m<sup>3</sup>/min, 7.1 kPa, 4.5kg

XGT BL HEPA MOTOR filter

**Robotic Cleaner - DRC300**  
 DRC300Z - Rs. 3,18,270



**18V** 3.0 L, 0.3 m/sec, 62 dB(A), 10.6 kg

LXI BL HEPA MOTOR filter

**Robotic Cleaner - DRC200**  
 DRC200Z - Rs. 1,63,910



**18V** 2.5 L, 0.3 m/sec, 7.8 kg

LXI BL MOTOR

**Brushless Cordless Upright Cleaner - VC010G**  
 VC010GZ - Rs. 87,320



**40V max** Dust: 50, 15 kPa, 9.2 kg

XGT BL HEPA MOTOR filter

**Brushless Cordless Upright Cleaner - DVC560**  
 DVC560Z - Rs. 73,530



**18V x2** Dust, Water 5 N/A L, 12 kPa, 9.0 kg

XGT BL HEPA MOTOR filter

**Brushless Cordless Polisher Scrubber - PS001G**  
 PS001GM101 - Rs. 1,36,650  
 PS001GZ - Rs. 94,990



**40V max** ø190, ø200, 600 rpm, 4.4 kg

XGT BL XPT MOTOR

**Cordless Cleaner - DCL184**  
 DCL184RF - Rs. 30,680  
 DCL184Z - Rs. 13,320



**18V** C 500 / P 330 mL. Cleaning: 1.4 m<sup>3</sup>/min 2.2 kg

LXI MOTOR

**Brushless Cordless Cleaner - CL003G**  
 CL003GD201 - Rs. 76,070  
 CL003GZ - Rs. 25,030



**40V max** Max air flow / 250 mL. 2.5 kg

XGT BL MOTOR

**Brushless Cordless Cleaner - CL002G**  
 CL002GD201 - Rs. 72,590  
 CL002GZ01 - Rs. 21,430



**40V max** D Bag / P Pack: 500 / 330 mL. 3.0 kg

XGT BL MOTOR

**Brushless Cordless Cleaner - DCL284F**  
 DCL284FRFW - Rs. 42,460  
 DCL284FRFB - Rs. 42,460  
 DCL284FRF - Rs. 42,460  
 DCL284FZW - Rs. 23,520  
 DCL284FZB - Rs. 23,520  
 DCL284FZ - Rs. 23,520



**18V** 1.2 m<sup>3</sup>/min, 730 mL, 1.6 kg

LXI BL MOTOR

**Battery Powered Backpack Blower - UB004C**  
 UB004CZ - Rs. 99,990



**40V max** 3.1, 2.1 dB(A), 55 - 200 min, 18.9 kg

BL XPT MOTOR

**Battery Powered Blower - UB003C**  
 UB003CZ - Rs. 51,490



**40V max** 24 N, 22,100 min<sup>-1</sup>, 3.1 kg

BL WG MOTOR

**Battery Powered Backpack Blower - UB002C**  
 UB002CZ - Rs. 95,050



**40V max** 22,000 RPM, 16.1 kg

BL WG XPT MOTOR

**Battery Powered Blower - UB001C**  
 UB001CZ - Rs. 49,030



**40V max** 24,000 RPM, 2.9 kg

BL WG MOTOR

**Brushless Cordless Blower - UB001G**  
 UB001GX002 - Rs. 2,76,650  
 UB001GM101 - Rs. 69,770  
 UB001GZ - Rs. 31,880



**40V max** 23,000 RPM, 3.9 kg

XGT BL MOTOR

**Brushless Cordless Blower - DUB362**  
 DUB362Z - Rs. 35,040



**18V x2** 13.4 m<sup>3</sup>/min, 54 m/s, 21000 rpm, 4.2kg

LXI BL XPT MOTOR

**Brushless Cordless Blower - DUB363**  
 DUB363PT2V - Rs. 88,280  
 DUB363ZV - Rs. 44,140



**18V x2** 7,850, rpm, 6.6 kg

LXI BL XPT MOTOR

**Cordless Blower - DUB361**  
 DUB361Z - Rs. 20,790

2  
 Electronic 2-Speed

18V + 18V → 36V

LXT XPT

18V x2 4.4 m<sup>3</sup>/min, 93 m/s, 17,000 rpm, 3.2kg

**Cordless Blower - DUB185**  
 DUB185Z - Rs. 9,150

3  
 Electronic 3-Speed

LXT

18V 35.8 kPa, 81 m/s, 81 m/s, 2.1 kg

**Brushless Cordless Blower - DUB184**  
 DUB184ST - Rs. 38,830  
 DUB184Z - Rs. 19,650

LXT BL XPT

18V 13.0 m<sup>3</sup>/min, 52.1 m/s, 18,000 rpm, 3.0kg

**Cordless Blower - DUB186**  
 DUB186RT - Rs. 28,230  
 DUB186Z - Rs. 9,860

3  
 Electronic 3-Speed

LXT

18V 3.2 m<sup>3</sup>/min, 68 m/s, 18000 rpm, 2.1 kg

**Brushless Cordless Blower Vacuum - DUB187**  
 100 mm

2 in 1

DUB187T001 - Rs. 48,050  
 DUB187Z - Rs. 29,700

LXT BL XPT

18V 13,500, 64.0 m/s, 25 mL, 4.0 kg

**Brushless Cordless Dust Blower - AS001G**  
 AS001GA101 - Rs. 40,430  
 AS001GZ - Rs. 21,430

XGT BL

40V max 10.3 kPa, 2.3 kg

**Brushless Cordless Dust Blower - DAS180**  
 10.3 kPa

DAS180RT - Rs. 46,680  
 DAS180Z - Rs. 21,220

LXT BL

18V 0-200 m/s, 3 dB(A), 1.7 kg

**Brushless Cordless High Pressure Washer - HW001G**  
 HW001GT201 - Rs. 1,82,060  
 HW001GZ - Rs. 1,05,030

XGT BL WG

40V max 3,350 rpm, 11.5 MPa, 13.4 kg

**Brushless Cordless High Pressure Washer - DHW080**  
 DHW080PT2 - Rs. 1,07,790  
 DHW080ZK - Rs. 67,470

2

18V + 18V → 36V

LXT BL WG

18V x2 8.0 MPa, 3,450rpm 7.7kg

**Cordless Pressure Washer - DHW180**  
 DHW180Z01 - Rs. 17,650

2

LXT XPT

18V 2.0 m (6.7 ft), G3/4, 18, 50 min, 2.7 kg

**High Pressure Washer - HW101**  
 Rs. 13,810

1300W, 100bar, 360L/hr, 6.5kg

**High Pressure Washer - HW102**  
 Rs. 16,120

1300W, 100bar, 360L/hr, 5.8kg

**High Pressure Washer - HW1200**  
 Rs. 44,780

1800W, 120bar, 420L/hr, 11.0kg

**High Pressure Washer - HW1300**  
 Rs. 46,790

1800W, 130bar, 420L/hr, 12.7kg

**Blower - UB1102**  
 303  
 Rs. 9,610

600W, 16000rpm, 2.2kg

## Lawn care / Grass care

**Battery Powered Grass Trimmer - UR101C**  
 UR101CZ - Rs. 61,220

BL ADT AFT WG XPT

40V max 0 - 7,000 rpm, 5.2kg

**Battery Powered Grass Trimmer - UR201C**  
 UR201CZ - Rs. 55,180

BL ADT AFT WG XPT

40V max 0 - 7,000 rpm, 4.7kg

**Brushless Cordless Grass Trimmer - UR012G**  
 UR012GZ02 - Rs. 1,01,850

XGT X2 80Vmax

XGT BL ADT AFT WG

40V max x2 0 - 6,800 RPM, 9.3 kg

**Brushless Cordless Grass Trimmer - UR013G**  
 UR013GT206 - Rs. 1,59,140  
 UR013GZ03 - Rs. 84,880

XGT BL AFT

40V max 0 - 6,700 RPM, 7.3 kg

**Brushless Cordless Grass Trimmer - UR016G**  
 UR016GM101 - Rs. 96,550  
 UR016GZ - Rs. 63,660

XGT BL WG

40V max M10 x 1.25 LH, 6,500 rpm, 5.3 kg

**Brushless Cordless Grass Trimmer - UR006G**

UR006GX001 - Rs. 2,99,000  
UR006GM101 - Rs. 96,340  
UR006GZ02 - Rs. 59,420

**new**

**XGT BL ADT AFT WG XPT**

**40V max** 4,600 RPM, 6.3 kg

**Brushless Cordless Grass Trimmer - UR007G**

UR007GM101 - Rs. 90,410  
UR007GZ01 - Rs. 53,480

**XGT BL ADT AFT WG XPT**

**40V max** 4,600 RPM, 5.9 kg

**Brushless Cordless Grass Trimmer - UR002G**

UR002GZ - Rs. 53,480

**XGT BL ADT AFT WG XPT**

**40V max** 0 - 6,500 RPM, 5.3 kg

**Brushless Cordless Grass Trimmer - DUR368A**

DUR368AZ - Rs. 42,980

**18V + 18V → 36V**

**LXI BL ADT AFT XPT**

**18V x2** 6,500 rpm, 4.7kg

**Brushless Cordless Grass Trimmer - DUR369A**

DUR369APT2 - Rs. 91,880  
DUR369AZ - Rs. 51,470

**18V + 18V → 36V**

**LXI BL ADT AFT XPT**

**18V x2** M10 x 1.25 LH 7,000 rpm, 6.5 kg

**Brushless Cordless Grass Trimmer - DUR190U**

DUR190URT1 - Rs. 67,470  
DUR190UZX1 - Rs. 30,680

**LXI BL ADT AFT XPT**

**18V** 6,000 rpm, 3.4 kg

**Cordless Grass Trimmer - DUR193**

DUR193RF - Rs. 36,890  
DUR193Z - Rs. 17,810

**LXI XPT**

**18V** 73.2 dB(A), 83.1 dB(A), 7,800 rpm, 2.6 kg

**Electric Grass Trimmer - UR3501**

Rs. 18,030

**1000W, 7500 rpm, 4.3kg**

**Brushless Cordless Multi Function Power Head - UX01G**

UX01GZX001 - Rs. 2,83,320  
UX01GZ - Rs. 39,250

**new**

**XGT BL AFT XPT**

**40V max** Pipe/Wd: 130/255mm, 3,000 spm, 12.6kg

**Brushless Cordless Multi Function Power Head - DUX60**

DUX60ZM3 - Rs. 49,010  
DUX60Z - Rs. 29,680

**18V + 18V → 36V**

**LXI BL AFT XPT**

**18V x2** 9700 rpm, 4.1kg



**Brushless Cordless Lawn Mower - LM004J**

530mm

LM004JB101 - Rs. 2,86,450  
LM004JZ - Rs. 1,80,360

**BL SOFT NOLOAD XPT**

**64V max** 534 mm (21"), 2,800 rpm, 34.6 kg

**Brushless Cordless Lawn Mower - LM003J**

480mm

LM003JB101 - Rs. 2,75,840  
LM003JZ - Rs. 1,69,750

**BL SOFT NOLOAD XPT**

**64V max** 480 mm (18-7/8"), 3,200 rpm, 33.8 kg

**Brushless Cordless Lawn Mower - LM002J**

534mm

LM002JM101 - Rs. 1,90,110

**BL SOFT NOLOAD XPT**

**64V max** w/ BL6440: 1,600 m<sup>2</sup>, 2,800 rpm, 27.6 kg

**Brushless Cordless Lawn Mower - LM001J**

480mm

LM001JM101 - Rs. 1,78,250

**BL SOFT NOLOAD XPT**

**64V max** w/ BL6440: 1,600 m<sup>2</sup>, 3,200 rpm, 26.1 kg

**Cordless Lawn Mower - LM004G**

430mm

LM004GM103 - Rs. 91,620  
LM004GZ - Rs. 51,490

**XGT XPT**

**40V max** 830 m<sup>2</sup>, 3,800 rpm, 18.2 kg

**Brushless Cordless Lawn Mower - LM003G**

380mm

LM003GM103 - Rs. 86,320  
LM003GZ - Rs. 47,640

**XGT BL AFT XPT**

**40V max** 780 m<sup>2</sup>, 3,800 rpm, 17.3 kg

**Brushless Cordless Lawn Mower - LM002G**

534mm

LM002GT201 - Rs. 2,34,460  
LM002GZ - Rs. 1,69,750

**XGT BL SOFT NOLOAD WG**

**40V max** 2,800 rpm, 34.7kg

**Brushless Cordless Lawn Mower - LM001G**

480mm

LM001GT201 - Rs. 2,23,850  
LM001GZ - Rs. 1,59,140

**XGT BL SOFT NOLOAD WG**

**40V max** 3,200 rpm, 33.0kg

**Battery Powered Lawn Mower - LM001C**

534mm

LM001CZ - Rs. 1,57,470

**BL SOFT NOLOAD XPT**

**40V max** 2.5 - 5.0 km/h / 70L / 2,800 rpm, 49.5 kg

**Cordless Lawn Mower - DLM539**

534mm

DLM539CT2 - Rs. 1,48,550  
DLM539Z - Rs. 1,11,730

**18V + 18V → 36V**

**LXI XPT**

**18V x2** 2.5 - 5.0 km/h, 3,000 rpm, 30.5 kg

**Brushless Cordless Lawn Mower - DLM533**

530mm  
 DLM533PT4 - Rs. 2,38,810  
 DLM533Z - Rs. 1,77,600

**18V + 18V → 36V**

**LXI BL XPT**

**18V x2** Cutting Width 534 mm (21") 2,800 rpm, 46.7 kg

**Cordless Lawn Mower - DLM480**

480mm  
 DLM480Z - Rs. 86,800

**18V + 18V → 36V**

**LXI XPT**

**18V x2** 20 - 100 mm, 3,100 rpm, 26.8 kg

**Brushless Cordless Lawn Mower - DLM530**

534mm  
 DLM530PT4 - Rs. 1,65,290  
 DLM530Z - Rs. 1,04,170

**18V + 18V → 36V**

**LXI BL XPT**

**18V x2** 2,800 rpm, 39.3 kg

**Cordless Lawn Mower - DLM481**

480mm  
 DLM481Z - Rs. 1,03,440

**18V + 18V → 36V**

**LXI XPT**

**18V x2** 20 - 100 mm, 3,100 rpm, 29.3 kg

**Brushless Cordless Lawn Mower - DLM532**

534mm  
 DLM532PT4 - Rs. 1,89,810  
 DLM532Z - Rs. 1,28,580

**18V + 18V → 36V**

**LXI BL XPT**

**18V x2** 2,800 rpm, 42.8 kg

**Brushless Cordless Lawn Mower - DLM462**

460mm  
 DLM462PT4 - Rs. 1,73,100  
 DLM462Z - Rs. 1,22,440

**18V + 18V → 36V**

**LXI BL XPT**

**18V x2** 3,300 rpm, 39.0 kg

**Cordless Lawn Mower - DLM431**

430mm  
 DLM431PT2 - Rs. 89,430

**18V + 18V → 36V**

**LXI XPT**

**18V x2** 93 dB(A), 3,600 min<sup>-1</sup>, 18.4 kg

**Cordless Lawn Mower - DLM432**

430mm  
 DLM432CT2 - Rs. 85,720  
 DLM432Z - Rs. 47,150

**18V + 18V → 36V**

**LXI XPT**

**18V x2** 3,600 rpm, 16.8 - 17.5 kg

**Cordless Lawn Mower - DLM382**

380mm  
 DLM382CM2 - Rs. 73,530  
 DLM382Z - Rs. 30,900

**18V + 18V → 36V**

**LXI XPT**

**18V x2** 3,700 rpm, 16.9 kg

**Cordless Lawn Mower - DLM330**

330mm  
 DLM330SM - Rs. 53,480  
 DLM330Z - Rs. 29,700

**LXI XPT**

**18V** 15.0 mm (9/16"), 4,300 rpm, 12.5 kg

**Cordless Lawn Mower - DLM230**

230mm  
 DLM230SF - Rs. 59,420  
 DLM230Z - Rs. 41,590

**LXI XPT**

**18V** 25.4 mm (N/A"), 7,000 rpm, 8.9 kg

**Electric Lawn Mower - ELM4621**

460mm  
 Rs. 55,060

**1,800W 2,950 rpm, 32.2kg**

**Electric Lawn Mower - ELM4121**

410mm  
 Rs. 40,040

**1,600W 3,400 rpm, 19.1kg**

**Electric Lawn Mower - ELM3720**

370mm  
 Rs. 24,910

**1,400W 3,400 rpm, 11.6kg**

**Brushless Cordless Vacuum Sweeper - VS001G**

Dust:24L  
 VS001GZ - Rs. 1,88,320

**XGT BL HEPA Filter**

**40V max** Main brush: 480 mm, 33.1 kg

**Brushless Cordless Scarifier - UV001G**

380mm  
 UV001GZ - Rs. 1,06,070

**XGT BL XPT**

**40V max** 50 L, 3,200 min<sup>-1</sup> rpm, 23.8 kg

**Brushless Cordless Scarifier - DUV320**

320mm  
 DUV320RT - Rs. 64,420  
 DUV320Z - Rs. 39,990

**new**

**LXI BL XPT**

**18V** 3,300 min<sup>-1</sup>, 30 L, 10.1-10.4 kg



**Excellent Storage Capability**

## Tree care / Hedge care

Tree care/  
Hedge care

### Brushless Cordless Chain Saw - UC021G

300mm UC021GZ - Rs. 51,150



**XGT BL MOTOR XPT**

40V max 3.5 m/s<sup>2</sup>, 200 mL, 101 dB(A), 4.5 kg

### Brushless Cordless Chain Saw - UC022G

350mm UC022GZ - Rs. 51,990



**XGT BL MOTOR XPT**

40V max 0 - 25.5 m/s, 200 mL, 101 dB(A), 5.4 kg

### Brushless Cordless Chain Saw - UC023G

400mm UC023GZ - Rs. 52,820



**XGT BL MOTOR XPT**

40V max 0 - 25.5 m/s, 200 mL, 101 dB(A), 5.5 kg

### Brushless Cordless Chain Saw - UC016G

400mm UC016GT101 - Rs. 95,510  
UC016GZ - Rs. 65,360



**XGT BL MOTOR WG**

40V max 3/8", 4,862, 200 mL, fpm, 6.5 kg

### Brushless Cordless Chain Saw - UC006G

250mm UC006GZ - Rs. 57,070



Carving Bar  
Captive nuts type

**XGT BL MOTOR WG**

40V max 1/4", 4,880, 200 mL, fpm, 4.5 kg

### Brushless Cordless Chain Saw - UC004G

350mm UC004GM101 - Rs. 86,780  
UC004GZ - Rs. 49,980



Captive nuts type

**XGT BL MOTOR WG**

40V max 3/8", 4,880, 200 mL, fpm, 4.6 kg

### Brushless Cordless Chain Saw - UC003G

300mm UC003GM101 - Rs. 85,620  
UC003GZ - Rs. 48,810



Captive nuts type

**XGT BL MOTOR WG**

40V max 3/8", 4,880, 200 mL, fpm, 4.5 kg

### Brushless Cordless Chain Saw - UC002G

250mm UC002GM101 - Rs. 84,460  
UC002GZ - Rs. 47,540



Captive nuts type

**XGT BL MOTOR WG**

40V max 3/8", 4,880, 200 mL, fpm, 4.4 kg

### Brushless Cordless Chain Saw Top Handle - DUC356

350 DUC356PT2 - Rs. 89,430



18V + 18V → 36V

**LXI BL MOTOR XPT**

18V x2 3/8", 200 mL, 0 - 20 m/s, 5.1 kg

### Brushless Cordless Chain Saw - DUC353

350mm/ DUC353Z - Rs. 50,290



18V + 18V → 36V

**LXI BL MOTOR XPT**

18V x2 3/8", 200 mL, 0 - 20 m/s, 5.5 kg

### Brushless Cordless Chain Saw - DUC355

350mm/ DUC355Z - Rs. 55,180



Captive Nut

18V + 18V → 36V

**LXI BL MOTOR XPT**

18V x2 3/8", 200 mL, 0 - 20 m/s, 5.4 kg

### Brushless Cordless Chain Saw - DUC357

350 mm DUC357RT - Rs. 71,240  
DUC357Z - Rs. 41,560



**LXI BL MOTOR XPT**

18V 3/8" 4.4 kg

### Electric Chain Saw - UC4550A

450 mm UC4550A - Rs. 35,720



2,000W, 870 m/min, 5.7 kg

### Electric Chain Saw - UC4041A

400 mm UC4041A - Rs. 19,190



1800W, 870m/min, 4.9 kg

### Brushless Cordless Pruning Saw - UC029G

150 UC029GM201 - Rs. 99,990  
UC029GZ - Rs. 33,320



new

**XGT BL MOTOR XPT**

40V max 55 mL, 8.0 m/s, 2.1 - 2.4 kg

### Brushless Cordless Pruning Saw - DUC150

150 mm DUC150SF - Rs. 44,040  
DUC150Z - Rs. 28,120



**LXI BL MOTOR XPT**

18V 8.0 m/s, 55 mL, 2.0 kg

### Brushless Cordless Pruning Saw - DUC101

100 mm DUC101SF - Rs. 42,460  
DUC101Z - Rs. 26,530



**LXI BL MOTOR XPT**

18V 8.0 m/s, 55 mL, 2.0 kg

### Brushless Cordless Pruning Saw - UC100D

100 mm UC100DWA - Rs. 37,140  
UC100DZ - Rs. 26,530



**LXI BL MOTOR XPT**

12V max 8.0 m/s, 55 mL, 2.0 kg

### Brushless Cordless Pole Saw - DUA200

20 cm DUA200RTE - Rs. 73,320  
DUA200Z - Rs. 39,990



**LXI BL MOTOR XPT**

18V 32 mm (1-1/4"), 200 mm (8"), 3.5 kg

### Brushless Cordless Pole Saw - UA004G

300mm UA004GM101 - Rs. 1,23,600  
UA004GZ - Rs. 85,620



Telescopic

**XGT BL MOTOR AFT WG XPT**

40V max 160 mL, 3/8", 3,940 fpm, 8.9 kg

**Brushless Cordless Pole Saw - UA003G**

300mm

UA003GM101 - Rs. 1,05,790  
UA003GZ - Rs. 68,980



Fixed **XGT BL AFT WG XPT**

40V max 160 mL, 3/8", 3,940 fpm, 7.3kg

**Brushless Cordless Pole Saw - DUA301**

DUA301PT2 - Rs. 1,22,440  
DUA301Z - Rs. 79,680



Telescopic **LXI BL XPT**

18V x2 0 - 3,940 FPM / 160 mL / 8.5 kg

**Brushless Cordless Pole Saw - DUA300**

DUA300PT2 - Rs. 1,01,650  
DUA300Z - Rs. 61,220



Fixed **LXI BL AFT XPT**

18V x2 103 dB(A) / 93 dB(A) / 6.9 kg

**Brushless Cordless Pole Hedge Trimmer - UN001G**

600mm

UN001GZ - Rs. 66,650



**XGT BL XPT**

40V max 2 grips, 38 mm (1-1/2"), 5.9 kg

**Brushless Cordless Hedge Trimmer - UH006G**

600mm

UH006GM201 - Rs. 1,20,100  
UH006GZ - Rs. 59,420



**XGT BL WG**

40V max 25.0 (1") mm, 4,000 spm, 5.0 kg

**Brushless Cordless Hedge Trimmer - UH007G**

750mm

UH007GM201 - Rs. 1,23,600  
UH007GZ - Rs. 63,020



**XGT BL WG**

40V max 25.0 (1") mm, 4,000 spm, 5.2 kg

**Brushless Cordless Hedge Trimmer - UH020G**

500mm

UH020GD101 - Rs. 69,100  
UH020GZ - Rs. 35,970



**XGT BL XPT**

40V max 20.0 mm (13/16"), 4,200 min<sup>-1</sup>, 4.2 kg

**Brushless Cordless Hedge Trimmer - UH021G**

600mm

UH021GD101 - Rs. 72,020  
UH021GZ - Rs. 37,870



**XGT BL XPT**

40V max 20.0 mm (13/16"), 4,200 min<sup>-1</sup>, 4.2 kg

**Brushless Cordless Hedge Trimmer - UH013G**

600mm

UH013GM101 - Rs. 94,000  
UH013GZ - Rs. 66,850



**XGT BL WG**

40V max 18 mm (11/16"), 5,000 spm, 4.5 kg

**Brushless Cordless Hedge Trimmer - UH014G**

750mm

UH014GM101 - Rs. 1,01,850



**XGT BL WG**

40V max 18 mm (11/16"), 5,000 spm, 4.7kg

**Brushless Cordless Hedge Trimmer - DUN500W**

500mm

DUN500WRTE - Rs. 88,280  
DUN500WZ - Rs. 51,470



**LXI BL XPT**

18V 520 W, 335 mm (1-3/8"), 4.3 kg

**Brushless Cordless Hedge Trimmer - DUN600L**

600mm

DUN600LRTE - Rs. 85,720  
DUN600LZ - Rs. 49,010



**LXI BL XPT**

18V 520 W, 35 mm (1-3/8"), 4.1 kg

**Cordless Pole Hedge Trimmer - DUN461W**

460mm

DUN461WSF - Rs. 34,700  
DUN461WZ - Rs. 22,180



**LXI XPT**

18V 1,800 CPM 3,600 SPM, 3.3 kg

**Brushless Cordless Hedge Trimmer - DUH502**

500mm/19"

DUH502RT - Rs. 61,220



**LXI BL XPT**

18V 2.5m/s<sup>2</sup>, 4400 spm, 4.5kg

**Brushless Cordless Hedge Trimmer - DUH602**

600mm/23"

DUH602RT - Rs. 64,930  
DUH602Z - Rs. 43,920



**LXI BL XPT**

18V 2.5m/s<sup>2</sup>, 4400 spm, 4.3kg

**Brushless Cordless Hedge Trimmer - DUH506**

500mm

DUH506RT - Rs. 53,050  
DUH506Z - Rs. 30,780



**LXI BL XPT**

18V 2.5 m/s<sup>2</sup>, 4,400 spm, 2.9 kg

**Brushless Cordless Hedge Trimmer - DUH606**

600mm

DUH606RT - Rs. 55,180  
DUH606Z - Rs. 32,890



**LXI BL XPT**

18V 2.5 m/s<sup>2</sup>, 4,400 spm, 3.0 kg

**Cordless Hedge Trimmer - DUH507**

500mm

DUH507F001 - Rs. 40,330  
DUH507Z - Rs. 24,400



**LXI XPT**

18V 2,700 spm, 3.0 kg

**Cordless Hedge Trimmer - DUH607**

600mm

DUH607F001 - Rs. 42,460  
DUH607Z - Rs. 26,530



**LXI XPT**

18V 2,700 spm, 3.1 kg

**Brushless Cordless Hedge Trimmer - DUH604S**

600mm

DUH604SZ - Rs. 60,160



**LXI BL XPT**

18V 2.5 m/s<sup>2</sup>, 4,400 spm, 3.9 kg

**Brushless Cordless Hedge Trimmer - DUH754S**

750mm

DUH754SZ - Rs. 63,430



**LXI BL XPT**

18V 2.5 m/s<sup>2</sup>, 4,400 spm, 3.9 kg

**Electric Hedge Trimmer - UH6570** 419

650mm Rs. 24,480



550W, 3200 spm, 3.7kg

**Electric Hedge Trimmer - UH4261** 419

420mm Rs. 17,410



400W, 3200 spm, 2.9kg

**Electric Hedge Trimmer - UH5261** 419

520mm Rs. 18,170



400W, 3200 spm, 3.0kg

**Brushless Cordless Edger - UE001G**

203mm UE001GZ - Rs. 59,990



**XGT BL XPT AFT**

40V max M10x 1.25 LHm, 59 mm (2-5/16"), 7.3 kg

**Battery Powered Pruning Shears - DUP362**

DUP362Z - Rs. 1,63,570



**LXI XPT**

18V x2 33 mm, 54 mm, 0.82kg

**Cordless Pruning Shear - DUP361**

DUP361Z - Rs. 1,46,930



**LXI XPT**

18V x2 33 mm, 54 mm, 0.8kg

**Battery Powered Pruning Shears - DUP180**

30 mm DUP180Z - Rs. 1,20,150



**LXI BL XPT**

18V 2.5 m/s<sup>2</sup> or less, 3 dB(A), 0.68 kg

**Brushless Cordless Pruning Shears - UP100D**

25 mm UP100DSMJ - Rs. 1,48,550  
UP100DZ - Rs. 1,27,310



**XGT BL XPT**

12V max 3 dB(A), 2.5 m/s<sup>2</sup> or less, 1.1 kg

**Brushless Cordless Backpack Mist Blower - PM001G**

15.0 L PM001GT201 - Rs. 2,16,300  
PM001GZ - Rs. 1,58,090



**XGT BL WG**

40V max 15,800-25,000 RPM, 15.7 kg

**Cordless Garden Sprayer - DUS158**

DUS158Z - Rs. 49,980



**LXI**

18V 15L, 0.5Mpa, 4.6kg

**Cordless Garden Sprayer - DUS108**

DUS108Z - Rs. 47,540



**LXI WG**

18V 15L, 0.5Mpa, 4.6kg

**Cordless Garden Sprayer - DVF104**

DVF104Z - Rs. 53,560



**LXI**

18V 10L, 0.3Mpa, 4.1kg

**Cordless Garden Sprayer - DUS054**

5L DUS054Z - Rs. 21,860



**LXI XPT**

18V 0.3 Mpa (3 kgf/cm<sup>2</sup>) 3.5 kg



**Cordless Garden Sprayer - DVF154**

DVF154Z - Rs. 54,650



**LXI**

18V 15L, 0.3Mpa, 4.4kg

## Transportation

**Battery Powered Wheelbarrow - DCU601**

DCU601Z - Rs. 10,29,990



**LXI BL XPT**

18V x2 475 - 1,020 mm, 145 kg

Electric Lift

**Battery Powered Wheelbarrow - DCU602**

DCU602Z - Rs. 10,29,990



**LXI BL XPT**

18V x2 mlc 300 kg, 147 kg

Bucket with Electric Dump

**Battery Powered Wheelbarrow - DCU603**

DCU603Z - Rs. 7,42,630



**LXI BL WG**

18V x2 mlc 300 kg, 124 kg

Bucket with Manual Dump

**Battery Powered Wheelbarrow - DCU604**

DCU604Z - Rs. 7,42,630



**LXI BL WG**

18V x2 mlc 300 kg, 120 kg

Carrier with Manual Dump

**Battery Powered Wheelbarrow - DCU605**

DCU605Z - Rs. 6,89,590



**LXI BL WG**

18V x2 mlc 300 kg, 106 kg

Flat Bucket

Tree care/  
Hedge care  
Transportation

# Measuring / Leveling

## Rechargeable Green Multi Line Laser - SK700GD

SK700GD - Rs. 95,510



**CXI XPT**

12V max 2 mm / 10 m, 4, IP54 1.2kg

## Rechargeable Red Multi Line Laser - SK700D

SK700D - Rs. 63,660



**CXI XPT**

12V max 2 mm / 10 m, 4, IP54 1.2kg

## Rechargeable Green Multi Line Laser - SK209GD

SK209GDZ - Rs. 1,50,770



2-Vertical line, 1- Horizontal

**CXI XPT**

12V max ±1 mm / 10 m, ±2°, 40 hrs, 1.6kg

## Rechargeable Green Multi Line Laser - SK40GD

1.5 mm

SK40GDZ



new

**CXI XPT**

12V 5 (4V1H), -10 - 40°C, 1.4 - 1.6 kg

## Laser Distance Measure - LD030P

30mm

Rs. 11,150



AAA 2X1.5V batteries, Pouch

(Laser class 2) : 635nm, 0.1 kg

## Laser Distance Measure - LD050P

50mm

Rs. 13,370



AAA 2X1.5V batteries, Pouch

(Laser class 2) : 635nm, 0.1kg

## Laser Distance Measure - LD080P

80mm

Rs. 22,270



AAA 2X1.5V batteries, Pouch

80m, (Laser class 2) : 635nm, 0.14kg

# Lights

## LED Flashlight - ML001G

ML001G - Rs. 5,150



Luminous flux : 160 lm

**XGT**

40V max BL4040, Up to: 55 hours, 160 lm, 1.3 kg

## Cordless Worklight - ML002G

ML002G - Rs. 11,360



Luminous flux : 710 lm

**XGT XPT USB**

40V max BL4040, Up to: 51 hours, 1,900 lx, 1.5 kg

## Cordless Worklight - ML003G

ML003G - Rs. 19,900



Luminous flux : High / Low: 1,100 / 450 lm

**XGT LXT**

40V max 1,900 / 800 lx, 20 QL, 3.4 kg

## Cordless Worklight - ML005G

ML005G - Rs. 28,430



Luminous flux : High / Med. / Low: 3,600 / 1,800 / 900 lm

**XGT LXT**

40V max LC Front / Sides: 6.0 / 6.4 m, 4.6 kg

## Cordless Flashlight - ML006G

ML006GX - Rs. 8,880



Luminous flux : High / Med. / Low: 500 / 250 / 100 lm

**XGT**

40V max w/ BL4040, 20 / 40 / 82 hours, 1.7 kg

## Cordless Flashlight - ML007G

ML007G - Rs. 16,520



Luminous flux : Spot / Flood / Spot-flood: 600 / 1,000 / 1,250 lm

**XGT XPT**

40V max 60,000 lx, 2.9 kg

## Cordless Worklight - ML009G

ML009G - Rs. 46,220



Luminous flux : High / Med. / Low: 10,000 / 4,000 / 2,000 lm

**XGT LXT**

40V max 4,300 / 1,000 lx 9.9 kg

## Cordless Worklight - ML011G

ML011G - Rs. 6,030



new

Luminous flux : 300 lm

**XGT USB**

40V max BL4040, Up to: 37 hours, 240 lx, 0.19 kg

## Cordless Bar Light - ML012G

ML012G - Rs. 32,330



Luminous flux : High / Med. / Low: 1,700 / 800 / 400 lm

**XGT LXT**

40V max 7 / 15 / 32 hours, 5,000 K, 2.0 kg

## Cordless Worklight - DML814

DML814 - Rs. 43,010



Luminous Flux : High / Med. / Low: 3,000 / 1,700 / 900 lm

Spot lighting & Area lighting

**LXT**

18V 1,250 / 400 lx, 4.7 / 5.6 m, 8.1 kg

## Cordless Worklight - DML813

DML813 - Rs. 44,910



Luminous Flux : High / Med. / Low: 3,000 / 1,700 / 900 lm

Spot lighting & Area lighting

**LXT**

18V 1,250 / 400 lx, 4.5 / 5.3 m, 7.9 kg

## Cordless & Cordless LED Worklight - DML805

DML805 - Rs. 14,360



Luminous Flux : 750 lm

**LXT XPT DC AC**

18V 1150 lx, 750 lm, 17 hrs, 2.7kg

## Comfort / Lifestyle

### LED Flashlight - DML815

DML815 - Rs. 3,750



Luminous Flux :160 lm

18V

Run Time, 30 hrs, 0.93 kg

LXT

### LED Flashlight - DML800

DML800 - Rs. 4,500



Luminous Flux :160 lm

18V

2000 lx, 100 lm, 30 hrs, 0.91kg

LXT

### Cordless Fan - CF002G

330mm(13")

CF002GZ - Rs. 17,300

3



40V max

240/170/120 m/min 5.1 kg

XGT

### Cordless Fan - DCF102

180mm

DCF102Z - Rs. 10,320

3



18V

4.6/3.8/3.0 L/min, 2.0kg

LXT

### Cordless Fan - CF101D

180mm

CF101DZ - Rs. 7,000

3



12V max

4.6/3.8/3.0 m<sup>3</sup>/min, 1.7 kg

CXI

### Brushless Cordless Fan Jacket - DFJ216

4



12V max

33/24.5/13.5 hours, 0.23 kg

LXT CXI BL

DFJ216Z2XL - Rs. 14,820  
DFJ216ZXL - Rs. 14,820  
DFJ216ZM - Rs. 14,820  
DFJ216ZL - Rs. 14,820

### Brushless Cordless Fan Jacket - DFJ210

4



12V max

33 hrs, 0.39 kg

LXT CXI BL

DFJ210ZL - Rs. 15,000  
DFJ210Z2XL - Rs. 12,650  
DFJ210ZXL - Rs. 12,650

### Brushless Cordless Fan Jacket - DFJ211

4



12V max

33hrs, 0.41 kg

LXT CXI BL

DFJ211Z2XL - Rs. 13,820  
DFJ211ZL - Rs. 13,820

### Brushless Cordless Fan Vest - DFV210

4



12V max

S/M/L/XL/2XL/3XL, 0.38 kg

LXT CXI BL

DFV210AL - Rs. 20,650  
DFV210AM - Rs. 20,650  
DFV210ZM - Rs. 19,650  
DFV210ZL - Rs. 19,650  
DFV210Z2XL - Rs. 19,650

### Brushless Cordless Fan Jacket - DFJ212

4



12V max

S/M/L/XL/2XL/3XL, 0.43 kg

LXT CXI BL

DFJ212ZM - Rs. 19,650  
DFJ212ZL - Rs. 19,650

### Brushless Cordless Fan Jacket - DFJ213

4



12V max

S/M/L/XL/2XL/3XL, 0.54 kg

LXT CXI BL

DFJ213AM - Rs. 21,650  
DFJ213AXL - Rs. 21,650  
DFJ213ZM - Rs. 18,820  
DFJ213ZL - Rs. 18,820

### Cordless Heated Jacket - DCJ205

DCJ205YXL - Rs. 19,650



18V

S/M/L/XL/2XL/3XL, 1.2 kg

LXT

### Cordless Heated Jacket - DCJ206

DCJ206YXL - Rs. 23,650  
DCJ206YL - Rs. 23,650



18V

S/M/L/XL/2XL/3XL, 1.2 kg

LXT

### Brushless Cordless Fan Jacket - DFJ214

4



18V

S/M/L/XL/2XL/3XL, 0.54 kg

LXT CXI BL

DFJ214CM - Rs. 27,490  
DFJ214CXL - Rs. 27,490  
DFJ214ZXL - Rs. 24,490

### Cordless Heated Vest - DCV202

DCV202Y2XL - Rs. 15,820  
DCV202YM - Rs. 15,820



18V

S/M/L/XL/2XL/3XL, 0.5 kg

LXT

### Battery Heated Base Layer Shirt - DCX201

DCX201A2XL - Rs. 43,620  
DCX201AXL - Rs. 43,620  
DCX201AL - Rs. 43,620  
DCX201CL - Rs. 43,620



18V

12V max 14.4V

XS, S, M, L, XL, 2XL, 3XL

LXT CXI

### Cordless Inflator - MP001G

161 PSI

MP001GZ - Rs. 19,110



40V max

1,110 kPa (161 PSI) [11.1 bar] 3.5 kg

XGT XPT

### Cordless Inflator - DMP181

161 PSI

DMP181Z - Rs. 18,460



18V

1,110 kPa (161 PSI) [11.1 bar] 2.8 kg

LXT XPT

### Cordless Inflator - DMP180

121 PSI

DMP180Z - Rs. 9,860



18V

830 kPa (121 PSI) [8.3 bar] 1.7 kg

LXT

### Cordless Inflator - MP100D

121 PSI

MP100DZ - Rs. 9,870



12V max

830 kPa 10L/hr, 1.3kg

CXI

## Cordless Heated Blanket - DCB200

DCB200B - Rs. 14,990



LXT

12V max

9.5 W / 4.5 W / 2.3 W, 0.58kg

## Cordless Cooler & Warmer Box - CW001G

CW001GZ - Rs. 1,30,690



-18°C - Cool  
+60°C - Hot

XGT LXT DC AC

40V max

20 L (5.3 gal) 16.1 kg

## Cordless Cooler & Warmer Box - CW002G

CW002GZ - Rs. 1,95,690



-18°C - Cool  
+60°C - Hot

XGT LXT DC AC

40V max

50 L (13.2 gal) 29.0 kg

## Cordless Cooler & Warmer Box - CW003G

CW003GZ - Rs. 1,06,940



-18°C - Cool  
+60°C - Hot

XGT LXT DC AC

40V max

7 L (1.8 gal) 9.4 kg

## Cordless Cooler and Warmer Box - DCW180

20 L DCW180Z - Rs. 1,22,440



-18°C - Cool  
+60°C - Hot

LXT DC AC

18V

20 L (5.3 gal), 14.3 kg



## Speciality tools

## Cordless Grease Gun - DGP180

DGP180RT - Rs. 61,220  
DGP180Z - Rs. 42,980



LXT

18V

69 MPa (10,000 PSI) 6.1 kg

## Cordless Vacuum Pump - DVP181

DVP181ZK - Rs. 1,16,700



LXT

18V

3,200min<sup>-1</sup>, 300 mL, 8.2kg

## Cordless Vacuum Pump - DVP180

DVP180RT - Rs. 54,650  
DVP180Z - Rs. 39,320



LXT

18V

3,840min<sup>-1</sup>, 115 mL, 3.5kg

## Cordless Caulking Gun - DCG180

max. DCG180ZX - Rs. 28,260  
DCG180ZB - Rs. 26,300



LXT

18V

0 - 28 mm/sec. 5000 N, 3.0 kg

## Submersible Pump - PF1010

PF1010 - Rs. 21,650

30 mm



new

Dirty Water

1,100W, 240 L/min, 6.6 kg

## Submersible Pump - PF0410

25 mm Rs. 15,150



Dirty Water

140 L/min (37 gal/min), 400W, 4.3 kg

## Submersible Pump - PF1100

4 mm PF1100 - Rs. 24,990



new

Clear Water

IP68, 250 L/min, 6.7 kg

## Cordless Heat Gun - DHG180

DHG180RT - Rs. 42,110  
DHG180ZK - Rs. 23,770



LXT

18V

550°C, 200 L/min, 1.3 kg

## Cordless Heat Gun - DHG181

DHG181RT - Rs. 44,450  
DHG181ZK - Rs. 26,200



LXT

18V

550°C, 200 L/min, 1.4 kg

## Heat Gun - HG6530VK

Rs. 15,060



2,000W, 50 - 650, 0.72kg

## Heat Gun - HG6030K

Rs. 8,810



2000W, 0.57kg

## Brushless Cordless Air Compressor - AC001G

AC001GZ - Rs. 59,990



XGT BL MOTOR

40V max

7.6 L (2 gal), 6,000 RPM, 11.6-12.8 kg



## Heat Gun - HG5030K

Rs. 7,540



1600W, 0.56kg



**M0600B** 64  
Drill 10mm  
  
Rs. 4,690  
350W, 3000 rpm, 1.2kg

**M6501B** 85  
High Speed Drill 6.5mm  
  
Rs. 5,250  
230W, 4500 rpm, 0.95kg

**M6200B** 303  
Drill 13mm  
  
Rs. 11,490  
800W, 700 rpm, 2.7kg

**M6600B** 303  
Mixer 165mm  
  
Rs. 11,740  
800W, 700 rpm, 2.7kg

**M0601B** 64  
Drill 10mm  
  
Rs. 4,930  
400W, 0 - 3,000 min<sup>-1</sup>, 1.2 kg



**M0801B** 85  
Hammer Drill 16mm  
  
Rs. 6,490  
500W, 3200 rpm, 1.7kg

**M8103B** 85  
Hammer Drill 13mm  
  
Rs. 6,650  
430W, 0 - 33,000 min<sup>-1</sup>, 1.8 kg

**M8700B** 459  
Rotary Hammer 22mm  
  
Rs. 15,600  
710W, 1100 rpm, 2.9kg

**M8701B** 459  
Combination Hammer 26mm  
  
Rs. 17,820  
800W, 1200 rpm, 2.7kg

**M8600B** 105  
Demolition Hammer 17mm  
  
Rs. 27,950  
900W, 2900 bpm, 5.4kg

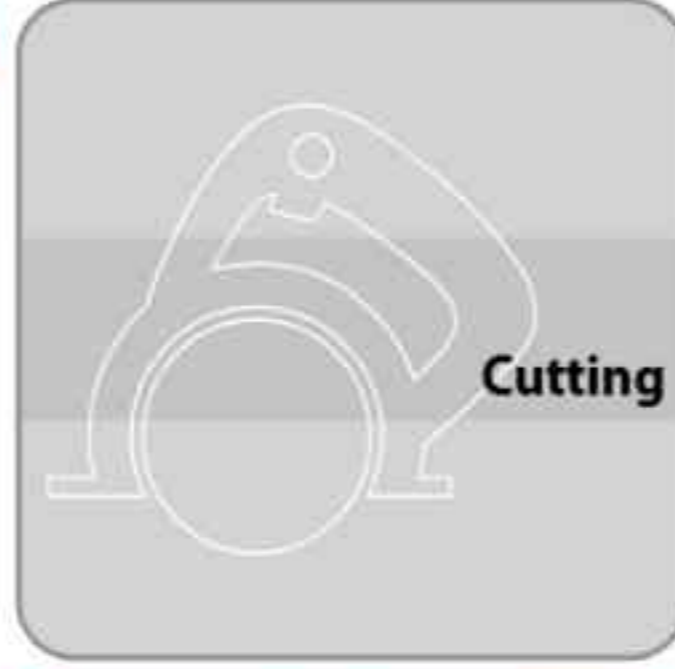

**M2401B** 203  
Portable Cut-off 355mm  
  
Rs. 21,730  
2,000W, 3800 rpm, 13.7kg

**M2402B** 203  
Portable Cut-off 355mm  
  
Rs. 24,710  
2,200W, 3900 rpm, 2.5 m 15.5kg

**M2403B** 203  
Portable Cut-off 355mm  
  
Rs. 24,710  
2,200W, 3900 rpm, 2.5 m 15.3kg

**M0401B** 303  
Cutter 110mm  
  
Rs. 8,000  
5" for wood cutting  
1,200W, 13,800 rpm, 2.6kg

**M4100B** 303  
Cutter 110mm  
  
Rs. 7,750  
1,200W, 13000 rpm, 2.9kg

**M4101B** 303  
Cutter 125mm  
  
Rs. 8,500  
1,250W, 12000 rpm, 3kg





**M0900B** 459  
Angle Grinder 100mm  
Rs. 5,630  
540W, 12000 rpm, 1.6kg

**M9506B** 459  
Angle Grinder 100mm  
Rs. 7,360  
720W, 11,000 rpm, 1.6kg

**M0910B** 459  
Angle Grinder 100mm  
Rs. 6,110  
540W, 12000 rpm, 1.6kg

**M9509B** 325  
Angle Grinder 100mm  
Rs. 7,340  
850W, 11000 rpm, 1.8kg

**M9512B** 459  
Angle Grinder 100mm  
Rs. 7,290  
720W, 11,000 rpm, 1.6kg

**M9513B** 325  
Angle Grinder 100mm  
Rs. 7,370  
850W, 11,000 rpm, 1.8kg

**M9002B** 303  
Angle Grinder 125mm  
Rs. 10,880  
1050W, 11,000 rpm, 2.8kg

**M9511B** 325  
Angle Grinder 125mm  
Rs. 8,150  
850W, 11,000 rpm, 2kg

**M0921B** 203  
Angle Grinder 230mm  
Rs. 12,750  
2,200W, 6,600 rpm, 5.3kg

**M0920B** 203  
Angle Grinder 180mm  
Rs. 12,090  
2,200W, 8,500 rpm, 5.0kg

**M9100B** 411  
Die Grinder 6mm  
Rs. 8,240  
480W, 33,000 rpm, 1.4kg



**M9200B** 419  
Finishing Sander 112x102mm  
Rs. 6,620  
180W, 14,000 opm, 0.9kg

**M9201B** 64  
Finishing Sander 93x185mm  
Rs. 6,890  
180W, 12,000 opm, 1.4kg

**M9202B** 419  
Random Orbit Sander 125mm  
Rs. 8,480  
240W, 12,000 opm, 1.1kg

**M9400B** 153  
Belt Sander 100mm  
Rs. 21,100  
940W, 6.2kg

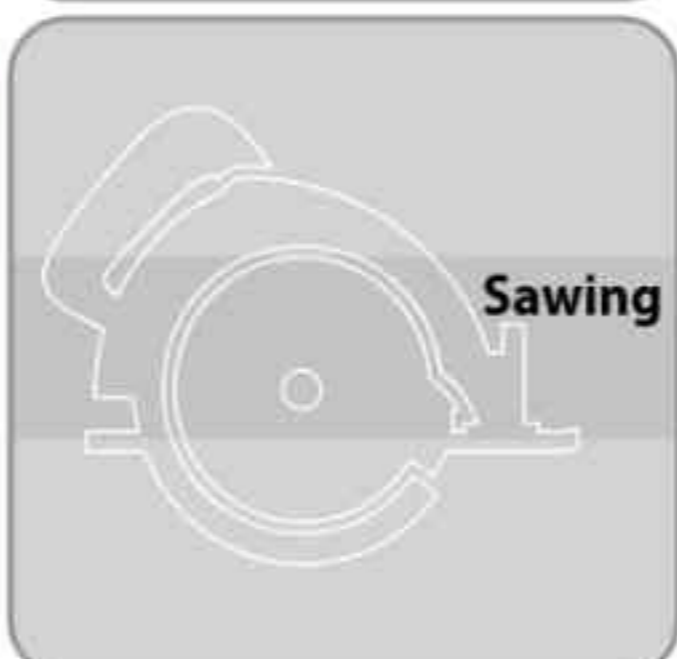

**M2300B** 23000123  
Compound Miter Saw 255mm  
Rs. 29,490  
1,500W, 4,200 min<sup>-1</sup>, 14.7kg

**M5801B** 303  
Circular Saw 185mm  
Rs. 11,610  
1050W, 4900 rpm, 3.5kg

**M4302B** 411  
Jig Saw  
Rs. 12,750  
450W, 3100 spm, 2.5kg

**M4301B** 64  
Jig Saw  
Rs. 10,120  
450W, 3100 spm, 1.9kg

**M4500KB** 303  
Recipro Saw  
Rs. 14,980  
1010W, 2800 spm, 3.1kg



**M1902B** 411  
Power Planer 82mm  
Rs. 9,380  
500W, 16,000 rpm, 2.7kg

**M3700B** 411  
Trimmer 6mm  
Rs. 7,630  
530W, 35,000 rpm, 1.4kg

**M3601B** 106  
Router (Plunge Type) 6.8mm  
Rs. 12,220  
900W, 27,000 rpm, 2.7kg

**M3600B** 211  
Router 12mm  
Rs. 20,220  
1,650W, 22,000 rpm, 5.5kg

**M3602B** 203  
Router 12mm  
Rs. 27,330  
1,650W, 22,000 rpm, 5.7kg

**M9800B** 459  
Multi Tool  
Rs. 16,480  
200W 15,000 - 22,000 1.3kg

















**M4000B** 85  
Blower  
Rs. 6,240  
530W, 8,500-16,000 rpm, 1.5kg



**MT413** 303  
Cutter 110mm  
Rs. 7,820  
1200W, 13000 rpm, 2.9 kg

**MT410** 303  
Cutter 110mm  
Rs. 7,560  
1200W, 13000 rpm, 3.0kg



<p><b>H.O.: Makita Power Tools India Pvt. Ltd.</b> Unit II Sy. Nos. 93/3 &amp; 93/4, Koralur village, Kasaba Hobli, Hoskote Taluk, Bengaluru - 560067 Email: info@makita.in Website: www.makita.in</p> 	<p><b>Makita Power Tools India Pvt. Ltd.</b> No 36/B, 1<sup>st</sup> &amp; Ground Floor, NTTF circle Peenya 2<sup>nd</sup> Stage, PIA, Bangalore - 560058 Tel: +91-+91-89518-59831</p> 	<p><b>Makita Power Tools India Pvt. Ltd.</b> Sahani Mansion, Chatribari Road, Guwahati, Kamrup Metropolitan, Assam - 781001 Tel: +91-77956-91083</p> 	<p><b>Makita Power Tools India Pvt. Ltd.</b> Aniket Estate, B/W. Savan &amp; Navjivan Hotel. Sarkhej Sanand Chokdi, S.G. Highway Sarkhej, Ahmedabad - 382210 Tel: +91-96112-42693</p> 		
<p><b>Makita Power Tools India Pvt. Ltd.</b> Shop No. 3, Lakod Complex, GIDC Makarpura, Vadodara - 390010 Tel: +91-96112-17265</p> 			<p><b>Makita Power Tools India Pvt. Ltd.</b> No. 30, Jawaharlal Nehru Salai, 100 Feet Road, Koyambedu, Chennai - 600107 Tel: +91-44-2479-2522,</p> 		
<p><b>Makita Power Tools India Pvt. Ltd.</b> Ward No. 19, New Ward No. 38, MIG-48, Awas Vikas, Rudrapur, Uttarakhand - 263153 Tel: +91-70425-97756</p> 			<p><b>Makita Power Tools India Pvt. Ltd.</b> D.No: 138, Rangakonar Street, Katoor, Coimbatore - 641009 Tel: +91-96002-91989</p> 		
<p><b>Makita Power Tools India Pvt. Ltd.</b> Shop No.104, First Floor, Plot No. PA0/J/121/122, J-Block, Near Quality Circle, MIDC Bhosari, PCMC, Pune - 411026 Tel: +91-63648-98763</p> 			<p><b>Makita Power Tools India Pvt. Ltd.</b> Khasra No: 90/1, Main Phirni Road, Village Bamnoli, New Delhi - 110 077 Tel: +91-70425-97751</p>		
<p><b>Makita Power Tools India Pvt. Ltd.</b> Block 11, in building no. F-1 situated at Antariksh Logipark, Dohole Village, Tal-Bhiwandi Maharashtra - 421302 Tel: +91-63648-98769</p>			<p><b>Makita Power Tools India Pvt. Ltd.</b> Access - B, HTL, Unit-2, B-34, Block No.B-18, Poddar Plaza VIP Route No.1, Kachi Mohalla, New Siyaganj, Indore, Madhya Pradesh - 452007 Tel: +91-73135-93608</p> 		
<p><b>Makita Power Tools India Pvt. Ltd.</b> P-46, Hide Road Extension Taratala, Brace Bridge Kolkata - 700088 West Bengal Tel: +91-85850-72679</p> 			<p><b>Makita Power Tools India Pvt. Ltd.</b> Door No: XVI/443A, Jubilee Road Maradu, Nettor Post, Cochin Kerala - 682040, Tel: +91-85904-32003</p> 	<p>Scan QR Code</p>  <p>Access Makita Website</p>	<p><b>Makita Power Tools India Pvt. Ltd.</b> Shop No. 24, Shiv Ranjani Complex Tata Kandra, Main Rd, Adityapur, Jamshedpur, Jharkhand - 831013 Tel: +91-657-2383024</p> 

































## Makita Experience Zone & Service Centre

Our success not only comes from producing #1 Quality tools, but also from our unparalleled service. From our Customer Service Representatives to our extensive Sales Team and Product Specialists, Makita is dedicated to delivering complete customer satisfaction.



Follow us on Social Media



- |   |   |   |   |
|---|---|---|---|
|  Double Insulation   |  Torque Setting 20           |  Revolving Hose          |  Bevel Cutting 45 left |
|  Variable Speed      |  Torque Setting 21           |  Static Free Hose        |  Bevel Cutting 45 LR   |
|  Constant Speed      |  Torque Setting 21_41        |  Depth Adjusting         |  Bevel Cutting L45 R5  |
|  Reversing           |  Torque Limiter              |  Sequential or Bump-fire |  Anti Vibration        |
|  Mechanical 2-Speed  |  Dust Collecting             |  Wire Collated Nail      |  Automatic Oiling      |
|  Mechanical 3-Speed  |  Bayonet Shank Jig Saw Blade |  Sheet Collated Nail     |  Chain Brake           |
|  Electronic 4-Speed  |  Makita Shank Jig Saw Blade  |  Hook & Loop             |  Auto Firing Stop      |
|  Electronic 3-Speed  |  Orbital Cutting             |  SDS-PLUS Shank          |  Automatic Oiling      |
|  Electronic 2-Speed  |  Built-in Job Light          |  SDS-MAX Shank           |  Carrying Case         |
|  Brake              |  Keyless Chuck              |  17mm Hex Shank         |   |
|  Torque Setting 16 |  Soft Start                |  28.6mm Hex Shank      |   |
|  Torque Setting 18 |  Stainless Tank            |  30mm Hex Shank        |   |



**Follow us on Social Media**



**H.O.: Makita Power Tools India Pvt. Ltd.**  
 Unit II Sy. Nos. 93/3 & 93/4, Koralur village,  
 Kasaba Hobli, Hoskote Taluk, Bengaluru - 560067  
 Email: info@makita.in Website: www.makita.in

**Marketed By:**

**Makita Service Centre:**

- |   |  |   |   |   |
|---|--|---|---|---|
| <b>Assam</b><br>Guwahati: +91-77956-91083 | <b>Delhi</b><br>New Delhi: +91-70425-97751                               | <b>Gujarat</b><br>Ahmedabad: +91-96112-42693<br>Vadodara: +91-96112-17265 | <b>Jharkhand</b><br>Jamshedpur: +91-657-2383024                               | <b>Karnataka</b><br>Peenya: +91-89518-59831     |
| <b>Kerala</b><br>Cochin: +91-85904-32003  | <b>Maharashtra</b><br>Bhiwandi: +91-63648-98769<br>Pune: +91-63648-98763 | <b>Madhya Pradesh</b><br>Indore: +91-73135-93608                          | <b>Tamil Nadu</b><br>Chennai: +91-44-2479-2522<br>Coimbatore: +91-96002-91989 | <b>Uttarakhand</b><br>Rudrapur: +91-70425-97756 |

**West Bengal**

kolkata: +91-85850-72679

All prices are subject to change without prior notice.  
 Makita Power Tools has the right to increase or decrease the price as per the market demand / supply.